

# MICHAEL PHELPS SIGNATURE SWIM SPAS™

 BY MASTER SPAS

*Michael Phelps*

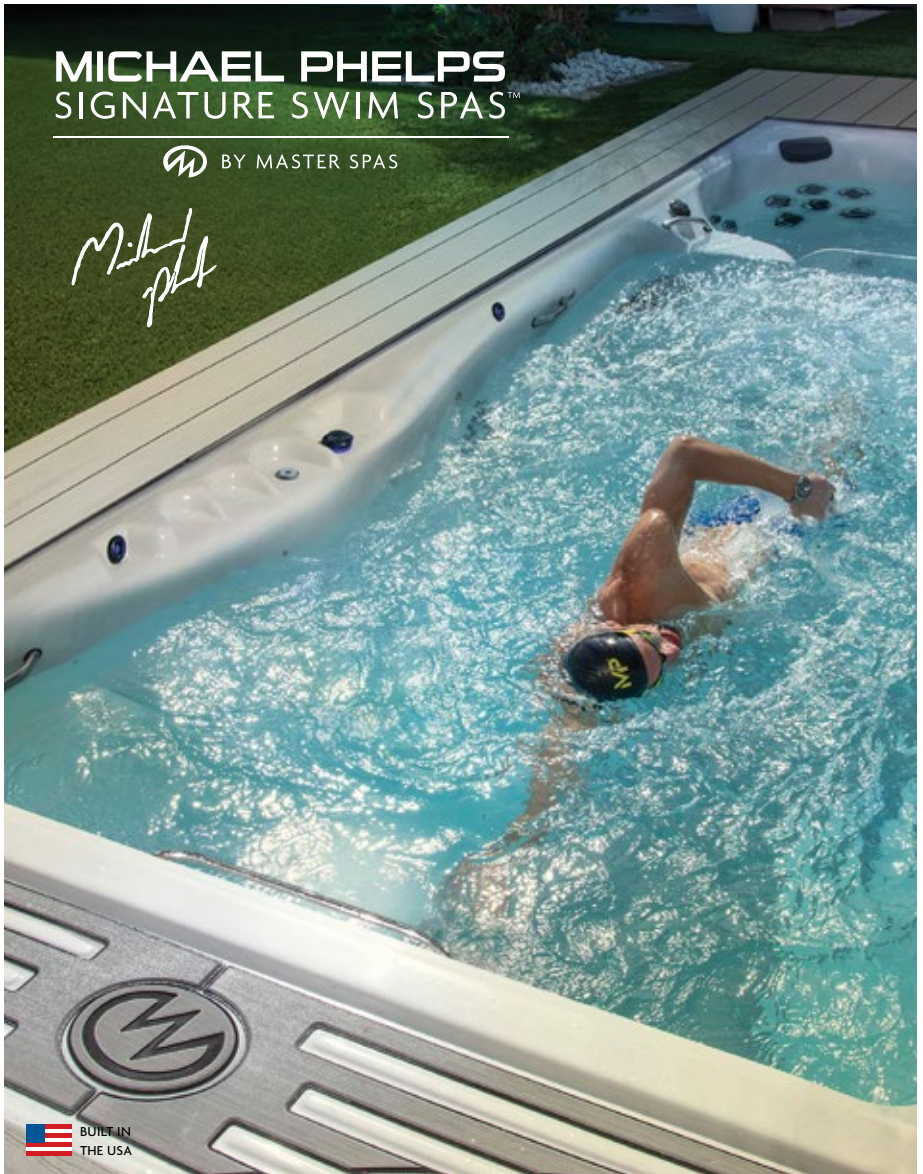

INTERNATIONAL VERSION

**OWNER'S MANUAL**  
& LIMITED WARRANTY

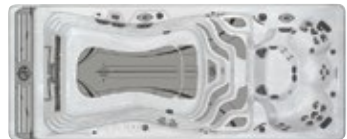

 Master Spas®

# MASTER SPAS OWNER'S MANUAL

---

## Welcome to the Ultimate in Relaxation!

Thank you for choosing your new swim spa built by Master Spas. For how-to videos and helpful tips on operating and maintaining your swim spa, please visit [www.masterspas.com/resources](http://www.masterspas.com/resources).

Please read the entire Owner's Manual before installing and using your swim spa. The goal of this manual is to provide you with safety and operational information plus some tips that will help you enjoy your swim spa to its fullest. At the time of print, this manual is accurate in its information. Master Spas reserves the right to change or improve its product without prior notice.

## REGISTER YOUR SWIM SPA

Please be sure to register your swim spa so we can efficiently assist with any questions you may have. Until your swim spa has been registered, Master Spas will not have record of your ownership. To register your swim spa, visit [www.masterspas.com/resources](http://www.masterspas.com/resources) and click on Spa Registration.

## SERIAL NUMBER LOCATION

The serial number for your swim spa is located near the filter area, on the swim spa system pack, or on the listing plate on the skirting. It will start with "H" followed by a 6 digit number. For example, H231234.

## RECORD OF OWNERSHIP

Name \_\_\_\_\_

Address \_\_\_\_\_

City \_\_\_\_\_ State \_\_\_\_\_ Zip \_\_\_\_\_

Phone Number (\_\_\_\_) \_\_\_\_\_ - \_\_\_\_\_ Date Purchased \_\_\_\_/\_\_\_\_/\_\_\_\_

Model \_\_\_\_\_ Serial # \_\_\_\_\_

Dealer Name \_\_\_\_\_

Service Tech Rep \_\_\_\_\_



**WATCH HOW-TO VIDEOS:**  
[masterspas.com/video-tutorials](http://masterspas.com/video-tutorials)



RELAX. IT'S

**Master Spas®**

6927 Lincoln Parkway  
Fort Wayne, IN 46804  
[masterspas.com](http://masterspas.com)

# TABLE OF CONTENTS

---

<b>Safety Instructions</b> .....	2-10
<b>Regulations</b> .....	11-13
<b>Compliance</b> .....	14
<b>VGB Suction Safety &amp; Maintenance Instructions</b> .....	15-16
<b>Glossary of Spa Terminology</b> .....	17-19
<b>The Advantages of EcoPur® Charge</b> .....	20-21
<b>Water Chemistry Terms You Should Know</b> .....	22-23
<b>Why Are Chemicals Important in a Swim Spa</b> .....	24
<b>Water Maintenance</b> .....	25-28
Recommended Ranges.....	25
Start-Up.....	26
Schedule.....	27
Troubleshooting Guide.....	28
<b>Regular Maintenance Procedures</b> .....	29-36
<b>Swim Spa Troubleshooting Guide</b> .....	37-38
<b>Winterizing &amp; Storing Your Swim Spa</b> .....	39
<b>Model Specifications</b> .....	40
<b>Installation Instructions</b> .....	41-51
Site Preparation/General Guidelines.....	41-43
Electrical Requirements.....	44-49
Initial Swim Spa Setup.....	50-51
<b>Operating Instructions</b> .....	52-99
Spa Controls - Icon Spa Touch.....	52-82
Spa Controls - Pump Diagrams.....	83-85
Propulsion System Controls.....	86-93
Propulsion System Technical Information.....	94
Fusion Air Sound System (if equipped).....	95-99
<b>Mast3rPur™ (if equipped)</b> .....	100-104
Mast3rPur UV+ Ozone Maintenance.....	100-102
Heat Pump Ready.....	103-104
<b>Nonslip, Comfort Floor System (if equipped)</b> .....	105
<b>International Limited Warranty</b> .....	106-109
<b>Swim Spa Care &amp; Maintenance Record</b> .....	110-112

## SAVE THESE INSTRUCTIONS

Included with your new swim spa is a safety sign. The sign is for you and your guest's protection and is suitable for outdoor use in wet locations. The sign should be placed in a location visible to all users of the swim spa.

Please take time to point out the physical location of the safety sign and the importance of the safety precautions displayed on the safety sign to all of your guests. Remember, your safety and the safety of anyone who enjoys the use of your swim spa is our utmost concern.

The sign should be mounted with screws or another type of permanent fastener. Additional or replacement signs can be obtained from your dealer or direct from the factory.

## INTRODUCTION

It's time to relax! You now have your very own portable swim spa by Master Spas. By fully understanding the operation of each of the features of your new Master Spas Swim Spa, you will be assured of many years of hassle-free, hot water therapy and fun.

Your safety is of paramount importance to the Master Spas family. We urge you to carefully read, understand, and follow all information in this user manual before installing and using the swim spa. These warnings, instructions, and safety guidelines address some common risks of water recreation, but they cannot cover all risks and dangers in all cases. Always use caution, common sense, and good judgment when enjoying any water activity. Retain this information for future use.

Through reading and totally understanding the important information in your owner's manual, you will realize that you now own THE ULTIMATE RELAXATION MACHINE!®



Safety graphical symbol ISO 7010, M002 –  
Refer to instruction manual/booklet

# NO DIVING

**DANGER: DIVING MAY  
RESULT IN SERIOUS  
INJURY OR DEATH.**



## IMPORTANT SAFETY INSTRUCTIONS

This swim spa is not intended for public/commercial use.

When installing and using this electrical equipment, basic safety precautions should be observed including the following:

### READ AND FOLLOW ALL INSTRUCTIONS

**WARNING** – To reduce the risk of injury, do not permit children to use this product unless they are closely supervised at all times.

A wire conductor is provided on this unit to connect a minimum 10AWG (5.26mm<sup>2</sup>) solid copper conductor between this unit and any metal equipment, metal enclosures of electrical equipment, metal water pipe, or conduit within 5 feet (1.5m) of the unit.

(For cord-connected/convertible units)

**DANGER** – Risk of injury.

- a) Replace damaged cord immediately.
- b) Do not bury cord.
- c) Connect to a grounded, grounding type receptacle only.

(For units intended for indoor use only)

**WARNING** – For indoor use only. This unit is not intended for outdoor use.

(For units intended for outdoor use only)

**WARNING** – For outdoor use only. This unit is not intended for indoor use.

<b>NO DIVING</b>	<b>DANGER: DIVING MAY RESULT IN SERIOUS INJURY OR DEATH.</b>	
------------------	--	---

## IMPORTANT SAFETY INSTRUCTIONS (CONT.)

(For units with GFCI)

**WARNING** – This product is provided with a ground-fault circuit interrupter located on the front panel of selected swim spas and on the power cord of 120 volt convertible spas. The GFCI must be tested before each use. With the product operating, open the service door. When the product stops operating, this merely indicates that the door is equipped with an electrical interlock. Next, push the test button on the GFCI and close the service door. The product should not operate. Now open the service door, push the reset button on the GFCI and close the service door. The product should now operate normally. When the product fails to operate in this manner, there is a ground current flowing indicating the possibility of an electric shock. Disconnect the power until the fault has been identified and corrected.

**DANGER** – Risk of Accidental Drowning. Extreme caution must be exercised to prevent unauthorized access by children. To avoid accidents, ensure that children cannot use this swim spa unless they are supervised at all times.

**DANGER** – Risk of Injury. The suction fittings in this swim spa are sized to match the specific water flow created by the pump. Should the need arise to replace the suction fittings or the pump, be sure that the flow rates are compatible. Never operate swim spa if the suction fittings are broken or missing. Never replace a suction fitting with one rated less than the flow rate marked on the original suction fitting.

**DANGER** – Risk of Electric Shock. Install at least 5 feet (1.5m) from all metal surfaces. As an alternative, a swim spa may be installed within 5 feet of metal surfaces if each metal surface is permanently connected by a minimum 8AWG (8.4mm<sup>2</sup>) solid copper conductor to the wire connector on the terminal box that is provided for this purpose. Be sure to review and comply with any overruling local or national applicable regulations.

**DANGER** – Risk of Electric Shock. Do not permit any electric appliance, such as a light, telephone, radio, or television, within 5 feet (1.5 m) of a swim spa.

**WARNING** – To reduce the risk of injury:

- a) The water in a swim spa should never exceed 104 °F (40 °C). Water temperatures between 100 °F (38 °C) and 104 °F (40 °C) are considered safe for a healthy adult. Lower water temperatures are recommended for young children and when swim spa use exceeds 10 minutes. Persons with any medical condition should seek medical advice before using a swim spa.

# NO DIVING

**DANGER: DIVING MAY  
RESULT IN SERIOUS  
INJURY OR DEATH.**



## IMPORTANT SAFETY INSTRUCTIONS (CONT.)

- b) Since excessive water temperatures have a high potential for causing fetal damage during the early months of pregnancy, pregnant or possibly pregnant women should limit swim spa water temperatures to 100°F (38°C) and duration of use and should also seek medical advice.
- c) Before entering a swim spa, the user should measure the water temperature with an accurate thermometer since the tolerance of water temperature-regulating devices varies.
- d) The use of alcohol, drugs, or medication before or during swim spa use may lead to unconsciousness with the possibility of drowning.
- e) Obese persons and persons with a history of heart disease, low or high blood pressure, circulatory system problems, or diabetes should consult a physician before using a swim spa.
- f) Persons using medication should consult a physician before using a swim spa since some medication may induce drowsiness while other medication may affect heart rate, blood pressure, and circulation.

(For swim spas with a gas heater)

**WARNING** – Risk of Suffocation. This swim spa is equipped with a gas heater and is intended for outdoor use only unless proper ventilation can be provided for an indoor installation.

## SAVE THESE INSTRUCTIONS

### **HYPERTHERMIA**

Hyperthermia occurs when the internal temperature of the body reaches a level several degrees above the normal body temperature of 98.6°F (37°C). Prolonged immersion in hot water may induce hyperthermia.

THE SYMPTOMS OF HYPERTHERMIA INCLUDE:

- Dizziness • Fainting • Drowsiness • Lethargy
- Increase in Internal Body Temperature

THE EFFECTS OF HYPERTHERMIA INCLUDE:

Unawareness of Impending Hazard • Failure to Perceive Heat • Failure to Recognize the Need to Exit Swim Spa • Physical Inability to Exit Swim Spa • Fetal Damage in Pregnant Women • Unconsciousness Resulting in a Danger of Drowning

**WARNING** – The use of alcohol, drugs, or medication can greatly increase the risk of hyperthermia.

<b>NO DIVING</b>	<b>DANGER: DIVING MAY RESULT IN SERIOUS INJURY OR DEATH.</b>	
------------------	--	---

## IMPORTANT SAFETY INSTRUCTIONS (CONT.)

**DANGER** – To reduce the risk of injury to persons, do not remove the suction grate. Suction through drains and skimmers is powerful when the jets in the swim spa are in use. Damaged covers can be hazardous to small children and adults with long hair. Should any part of the body be drawn into these fittings, turn off the swim spa immediately. As a precaution, long hair should not be allowed to float in the swim spa.



EN 17125 – Do not put finger in massage jet

**WARNING** – Install the swim spa so that water can be easily drained out of the compartment containing electrical components so as not to damage equipment. When installing the swim spa make sure to allow for an adequate drainage system to deal with any overflow water. Please allow for at least 3 feet of clearance around the perimeter of the swim spa to provide enough room to access for servicing. Contact your local dealer for their specific requirements.

**WARNING** – The swim spa should be covered with an approved locking cover when not in use, to prevent unauthorized entry and injuries.

**WARNING** – People with infections, sores or the like should not use the swim spa. Warm and hot water temperatures may allow the growth of infectious bacteria if not properly disinfected.

**CAUTION** – Safe temperatures for swimming or aquatic exercise is around 80°F (26.7°C).

**CAUTION** – Risk of Electrical Shock. Do not leave audio compartment open. Audio CD controls are not to be operated while inside the swim spa.

**CAUTION** – Replace components only with identical components.

**WARNING** – Risk of Electric Shock. Do not connect any auxiliary components (for example, additional speakers, headphones, additional audio/ video components etc.) to the system. These units are not provided with an outdoor antenna.

Do not service this product yourself as opening or removing covers may expose you to dangerous voltage or other hazards. Refer all servicing to qualified service personnel. If the power supply cord(s) are damaged, water is entering the speaker, audio compartment, or any other component in the electrical equipment compartment area, the protective shield is showing signs of deterioration, or there are signs of other potentially hazardous damage to the unit, turn off the circuit breaker from the wall and refer servicing to qualified personnel.



<b>NO DIVING</b>	<b>DANGER: DIVING MAY RESULT IN SERIOUS INJURY OR DEATH.</b>	
------------------	--	---

## IMPORTANT SAFETY INSTRUCTIONS (CONT.)

The unit should be subjected to periodic routine maintenance once every quarter to make sure that the it is operating properly.

**DANGER** – Risk of Electric Shock. A green colored terminal or a terminal marked G, GR, Ground, Grounding or the symbol shown in Figure 14.1 of UL 1563 is located inside the supply terminal box or compartment. To reduce the risk of electric shock, this terminal must be connected to the grounding means provided in the electric supply service panel with a continuous copper wire equivalent in size to the circuit conductors supplying this equipment.

At least two lugs marked “Bonding Lugs” are provided on the external surface or on the inside of the supply terminal box or compartment. To reduce the risk of electric shock, connect the local common bonding grid in the area of the swim spa to these terminals with an insulated or bare copper conductor not smaller than 10AWG.

All field installed metal components such as rails, ladders, drains, or other similar hardware within 10 feet (3m) of the swim spa shall be bonded to the equipment grounding bus with copper conductors not smaller than 10AWG.

## SAVE THESE INSTRUCTIONS

## SAFETY INSTRUCTIONS

---

**WARNING:** CHILDREN SHOULD NOT USE SWIM SPAS OR HOT TUBS WITHOUT ADULT SUPERVISION.

**AVERTISSEMENT:** NE PAS LAISSER LES ENFANTS UTILISER UNE CUVE DE RELAXATION SANS SURVEILLANCE.

**WARNING:** DO NOT USE SWIM SPAS OR HOT TUBS UNLESS ALL SUCTION GUARDS ARE INSTALLED TO PREVENT BODY AND HAIR ENTRAPMENT.

**AVERTISSEMENT:** POUR ÉVITER QUE LES CHEVEUX OU UNE PARTIE DU CORPS PUISSENT ÊTRE ASPIRES, NE PAS UTILISER UNE CUVE DE RELAXATION SI LES GRILLES DI PRISE D'ASPIRATION NE SONT PAS TOUTES EN PLACE.

**WARNING:** PEOPLE USING MEDICATIONS AND/OR HAVING AN ADVERSE MEDICAL HISTORY SHOULD CONSULT A PHYSICIAN BEFORE USING A SWIM SPA OR HOT TUB.

**AVERTISSEMENT:** LES PERSONNES QUI PRENNENT DES MÉDICAMENTS OU ONT DES PROBLÈMES DE SANTÉ DEVRAIENT CONSULTER UN MÉDECIN AVANT D'UTILISER UNE CUVE DE RELAXATION.

**WARNING:** PEOPLE WITH INFECTIOUS DISEASES SHOULD NOT USE A SWIM SPA OR HOT TUB.

**AVERTISSEMENT:** LES PERSONNES ATTEINTES DE MALADIES INFECTIEUSES NE DEVRAIENT PAS UTILISER UNE CUVE DE RELAXATION.

**WARNING:** TO AVOID INJURY EXERCISE CARE WHEN ENTERING OR EXITING THE SWIM SPA OR HOT TUB.

**AVERTISSEMENT:** POUR ÉVITER DES BLESSURES, USER DE PRUDENCE EN ENTRANT DANS UNE CUVE DE RELAXATION ET EN SORTANT.

**WARNING:** DO NOT USE DRUGS OR ALCOHOL BEFORE OR DURING THE USE OF A SWIM SPA OR HOT TUB TO AVOID UNCONSCIOUSNESS AND POSSIBLE DROWNING.

**AVERTISSEMENT:** POUR ÉVITER L'ÉVANOUISSEMENT ET LA NOYADE ÉVENTUELLE, NE PRENDE NI DROGUE NI ALCOOL AVANT D'UTILISER UNE CUVE DE RELAXATION NI QUAND ON S'Y TROUVE.

**WARNING:** PREGNANT OR POSSIBLY PREGNANT WOMEN SHOULD CONSULT A PHYSICIAN BEFORE USING A SWIM SPA OR HOT TUB.

**AVERTISSEMENT:** LES FEMMES ENCEINTES, QUE LEUR GROSSESSE SOIT CONFIRMÉE OU NON, DEVRAIENT CONSULTER UN MÉDECIN AVANT D'UTILISER UNE CUVE DE RELAXATION.

**WARNING:** WATER TEMPERATURE IN EXCESS OF 38 °C MAY BE INJURIOUS TO YOUR HEALTH.

**AVERTISSEMENT:** IL PEUT ÊTRE DANGEREUX POUR LA SANTÉ DE SE PLONGER DANS DE L'EAU A PLUS DE 38 °C.

**WARNING:** BEFORE ENTERING THE SWIM SPA OR HOT TUB MEASURE THE WATER TEMPERATURE WITH AN ACCURATE THERMOMETER.

**AVERTISSEMENT:** AVANT D'UTILISER UNE CUVE DE RELAXATION MESURER LA TEMPÉRATURE DE L'EAU À L'AIDE D'UN THERMOMÈTRE PRÉCIS.

## SAFETY INSTRUCTIONS

---

**WARNING:** DO NOT USE A SWIM SPA OR HOT TUB IMMEDIATELY FOLLOWING STRENUOUS EXERCISE.

**AVERTISSEMENT:** NE PAS UTILISER UNE CUVE DE RELAXATION IMMÉDIATEMENT APRÈS UN EXERCISE FATIGANT.

**WARNING:** PROLONGED IMMERSION IN A SWIM SPA OR HOT TUB MAY BE INJUROUS TO YOUR HEALTH.

**AVERTISSEMENT:** L'UTILISATION PROLONGÉE D'UNE CUVE DE RELAXATION PEUT ÊTRE DANGEREUSE POUR LA SANTÉ.

**WARNING:** DO NOT PERMIT ELECTRIC APPLIANCES (SUCH AS LIGHT, TELEPHONE, RADIO, OR TELEVISION) WITHIN 1.5 M OF THIS SWIM SPA OR HOT TUB.

**AVERTISSEMENT:** NE PAS PLACER D'APPAREIL ÉLECTRIQUE (LUMINAIRE, TÉLÉPHONE, RADIO, TÉLÉVISEUR, ETC) À MOINS DE 1.5 M DE CETTE CUVE DE RELAXATION.

**CAUTION:** MAINTAIN WATER CHEMISTRY IN ACCORDANCE WITH MANUFACTURER'S INSTRUCTION.

**ATTENTION:** LA TENEUR DE L'EAU EN MATIÈRES DISSOUTES DOIT ÊTRE CONFORME AUX DIRECTIVES DU FABRICANT.

Hyperthermia occurs when the internal temperature of the body reaches a level several degrees above the normal body temperature of 98.6 °F (37 °C). The symptoms of hyperthermia include drowsiness, lethargy, and an increase in the internal temperature of the body. The effects of hyperthermia include:

- (a) unawareness of impending hazard;
- (b) failure to perceive heat;
- (c) failure to recognize the need to exit swim spa;
- (d) physical inability to exit swim spa;
- (e) fetal damage in pregnant women; and
- (f) unconsciousness and danger of drowning.

**WARNING:** THE USE OF ALCOHOL OR DRUGS CAN GREATLY INCREASE THE RISK OF FATAL HYPERTHERMIA IN HOT TUBS AND SWIM SPAS.

**AVERTISSEMENT:** LA CONSOMMATION D'ALCOOL OU DE DROGUE AUGMENTE CONSIDÉRABLEMENT LES RISQUES D'HYPERTHERMIE MORTELLE DANS UNE CUVE DE RELAXATION.

# SAFETY INSTRUCTIONS

---

For swim spas relying on a specific means of egress, such means shall not be removed when the swim spa is in use.

**DANGER** – This appliance is not intended for use by persons (including children) with reduced physical, sensory or mental capabilities, or lack of experience and knowledge, unless they have been given supervision or instruction concerning use of the appliance by a person responsible for their safety.

Children should be supervised to ensure that they do not play with the appliance.



Safety graphical symbol ISO 20712-1, WSM002 – Keep children under supervision in the aquatic environment

**DANGER** – Risk of Accidental Drowning (especially children under 5 years). Caution shall be exercised to prevent unauthorized access to the swim spa by children. This can be reached by an adult supervisor securing the means of access or installing a safety protection device to the swim spa. To avoid accidents during swim spa use, ensure that children are kept under constant adult supervision).

Avoid putting the head under water at all times.

Avoid swallowing swim spa water.

**DANGER** – No Diving.



Safety graphical symbol ISO 20712-1, WSP005 – No Diving

## REGULATIONS

---

Below are important requirements that you should be aware of prior to using and operating your swim spa per European Standard EN 17125:2018.

### MEANS OF ACCESS AND SWIM SPA ACCESSORIES

The steps in the swim area can be used to access the spa side with dual water body models such as Trainer 19, Challenger 19 and Momentum.

All accessories that are supplied shall be safe and compatible with the swim spa as required by section 4.3 of EN17125. The user can only use accessories exclusively provided by the swim spa manufacturer (i.e. Master Spas manufactured insulating cover) for safety reasons (section 6.1 d).

Means of access is not provided with the swim spa. Accessories necessary for means of access must meet European standard EN 17125. The type of means of access to the swim spa must be considered (ingress and/or egress where not obvious). Access means can be either secured or unsecured. See Accessory Manufacturer Specifications for the following:

- the commercial name or reference;
- an indication of the maximum allowable weight permitted on the means of access;
- illustrations repeating the overall dimensions of the product;
- stepping height and width of the wall, if appropriate for ingress and egress;
- if appropriate, any indication concerning the construction of onsite reinforcement works for installing the means of access;
- the warranty period(s) of the means of access;
- Proper care instructions for winterization.

**NOTE:** A handrail may be proposed with the means of access in case of use by people with mobility issues.

Consult manufacturer or contractor for proper care during winterization and to review maximum weight allowed. Means of access shall not be used for any purpose besides for swim spa entry. Stairs used for entry to the spa/swim spa must comply with section 4.6.4 of EN 17125.

A cover lifter, when applicable, should be designed to keep the cover off the ground when in use, to avoid dirt and debris getting on the cover.

### ELECTRICAL REQUIREMENTS OF SWIM SPA ACCESSORIES

Electrically operated accessories shall comply with electrical safety standards and regulations (national and European). They must be assembled in accordance with the manufacturer's manual. The electrical installation of any material related to the swim spa and its surroundings shall comply with national requirements.

### SAFETY DEVICES

- A safety cover or other safety protection device(s) shall be used, or all doors and windows (where applicable) shall be secured to prevent unauthorized access to the swim spa.
- Barriers, covers, alarms, or similar safety devices are helpful aids, but they are not substitutes for continuous and competent adult supervision.

### SAFETY EQUIPMENT

- It is recommended to keep rescue equipment (e.g. a ring buoy) by the swim spa (if appropriate).
- Keep a working phone and a list of emergency phone numbers near the swim spa.

# REGULATIONS

---

## SAFE USE OF THE SWIM SPA

- Encourage all users especially children to learn how to swim.
- Learn Basic Life Support (Cardiopulmonary Resuscitation - CPR) and refresh this knowledge regularly. This can make a life-saving difference in the event of an emergency.
- Instruct all swim spa users, including children, what to do in case of an emergency.
- Never dive into any shallow body of water. This can lead to serious injury or death.
- Do not use the swim spa when using alcohol or medication that may impair the bather's ability to safely use the swim spa.
- When covers are used, remove them completely from the water surface before entering the swim spa.
- Protect swim spa occupants from water related illnesses by advising them to keep the water treated and to practice good hygiene. Consult the water treatment guidelines in this manual.
- Store chemicals out of the reach of children.
- Use the signage provided on the swim spa or within 2 000 mm (78.74 in) of the swim spa in a prominent visible position.
- Removable ladders, when removed, shall be stored safely where children cannot climb on them.

## NON SWIMMERS SAFETY

- Continuous, active, and vigilant supervision of weak swimmers and non-swimmers especially in exercise swim spas, by a competent adult is required at all times (remembering that children under five years of age are at the highest risk of drowning).
- Designate a competent adult to supervise the swim spa each time it is being used.
- Weak swimmers or non-swimmers should wear personal protection equipment, especially when using the exercise swim spa.
- When the swim spa is not in use, or unsupervised, remove all toys from the swim spa and its surrounding area to avoid attracting children to the swim spa.

## PERMISSIBLE OPENINGS

Requirements on the size of the accessible openings shall be as follows.

### OPENINGS PRESENTING A RISK OF ENTRAPMENT OF FINGERS, TOES, HANDS, FEET:

- If the lowest point of the opening is located up to and including the first 500 mm of the designed water surface, no requirements will apply;
- If the lowest point of the opening is located more than 500 mm below the designed water surface, the requirements of EN 16582-1 (domestic pools) will apply with the following exception: Hydro-massage jets with opening diameters > 8 mm or < 25 mm are also allowed below 500 mm of the designed water depth, when they are installed in designated seating/lounging areas including foot massage jets and provided with the warning sign with icon below about the risk of finger entrapment.



**EN 17125 – Do not put finger in massage jet**

- If the depth of penetration is less than 10 mm, no requirements apply.

### OPENINGS PRESENTING A RISK OF ENTRAPMENT OF HEAD OR NECK:

If the opening is fully located under the water surface, permissible opening requirements of EN 16582-1 (domestic pools) will apply.

## REGULATIONS

---

### USE OF NON-WATER TREATMENT CHEMICALS

For chemicals unrelated to water maintenance/treatment (i.e. cleaning products and aromatherapy), only use appropriate chemicals approved by the applicable regulations and the chemicals referenced in this manual.

### SWIM SPA SURROUNDINGS

Barefoot areas and relaxing areas shall be considered in the cleaning process as well. No cleaning water may flow into the swim spa or swim spa water cycle. The dirt and cleaning agents shall be rinsed carefully to drain to surrounding areas away from the swim spa.

### OPERATIONAL ADVICE

- To allow good circulation when the swim spa purges and filters so that chemically treated water flushes through all plumbing; all jets should be left in their open position, air controls/aeration valves closed and water diverters adjusted to half way (diverting water to all jets).
- Whenever the swim spa is emptied, the filter(s) should be cleaned (and drained/dried, where applicable).
- In the absence of automated and/or continuous water treatment (measurement and chemical dosage) any manual dosing of chemicals shall not be performed while bathers are present in the swim spa.
- Where an automatic system is installed, periodic checks are still required as per Water Maintenance instructions in this manual.
- Master Spas recommends fast dissolving chlorine granules (sodium dichlor). It is not recommended that chlorine tablets and a floater be used.

### ENERGY EFFICIENCY ADVICE

In order to minimize energy consumption in everyday use of the swim spa, always use an insulating cover to minimize calorific losses at the water surface (due to evaporation, convection and conduction) when the swim spa is not in use.

**NOTE:** The recommended minimum thermal specifications of an insulating cover is 5"-3" thickness taper with 1.25 lb density foam.

## COMPLIANCE

---

Relax and rest assured that your Master Spas manufactured swim spa has been built with safety in mind. We manufacture our self-contained swim spas to meet a stringent list of industry standards.

Our jetted swim spas comply with the following industry standards:

- UL 1563 Standard for Electric Spas, Equipment Assemblies and Associated Equipment
- ICC ISPSC International Swimming Pool & Spa Code
- European Standard EN 17125 for Domestic Spas/Whirlpool Spas/Hot Tubs – Safety Requirements and Test Methods
- VGB Virginia Graeme Baker Pool and Spa Safety Act (Certified by UL to UL 1563)
- ANSI/APSP-6 Standard for Portable Spas
- ANSI/APSP/ICC-14 Standard for Portable Spa Energy Efficiency
- CEC Title 20 Appliance Efficiency Regulation
- CSA C22.2 No. 218.1 Spas, Hot Tubs and Associated Equipment
- IAPMO/ANSI Z124.7 Prefabricated Plastic Spa Shells
- CE - EN 60335-2-60 Household and Similar Electrical Appliances – Safety: Particular Requirements for Whirlpool Baths and Whirlpool Spas
- CE - EN 60335-1 Household and Similar Electrical Appliances – Safety: General Requirements
- 2014/35/EU Low Voltage Directive
- 2014/30/EU EMC Directive
- 93/68/EEC CE Marking Directive
- AS1926.3-2010 RC2016
- 2014/53/EU Wireless Directive
- UKCA Electromagnetic Compatibility Regulations 2016
- UKCA Electrical Equipment (Safety) Regulations 2016
- UKCA Radio Equipment Regulations 2017
- UKCA The Restriction of the Use of Certain Hazardous Substances in Electrical and Electronic Equipment Regulations 2012
- EU REACH Compliant

Our propulsion swim spas comply with the following industry standards:

- UL 1563 Standard for Electric Spas, Equipment Assemblies and Associated Equipment
- ICC ISPSC International Swimming Pool & Spa Code
- VGB Virginia Graeme Baker Pool and Spa Safety Act (Certified by UL to UL 1563)
- ANSI/APSP-7 (Propulsion system only Certified by NSF) Standard for Suction Entrapment Avoidance in Swimming Pools, Wading Pools, Spas, Hot Tubs and Catch Basins
- ANSI/APSP-6 Standard for Portable Spas
- ANSI/APSP/ICC-14 Standard for Portable Spa Energy Efficiency
- CEC Title 20 Appliance Efficiency Regulation
- CSA C22.2 No. 218.1 Spas, Hot Tubs and Associated Equipment
- IAPMO/ANSI Z124.7 Prefabricated Plastic Spa Shells
- CE - EN 60335-2-60 Household and Similar Electrical Appliances – Safety: Particular Requirements for Whirlpool Baths and Whirlpool Spas
- CE - EN 60335-1 Household and Similar Electrical Appliances – Safety: General Requirements
- 206/95/EC EC Low Voltage Directive
- 204/108/EMC Directive
- 93/68/EEC CE Marking Directive





# VGB SUCTION SAFETY & MAINTENANCE INSTRUCTIONS

---

## VGB 2008:

### WARNING



Read and follow all instructions in this manual and on the suction fitting. Failure to follow instructions can cause severe injury and/or death.



Failure to remove pressure test plugs and/or plugs used in winterization of the spa/swim spa from the suction outlets can result in an increased potential for suction entrapment.



Suction outlet components have a finite life. The cover/grate should be inspected frequently and replaced at least every seven years, or if found to be damaged, broken, cracked, missing, or not securely attached.



If the fitting is missing or broken, replace with a fitting of equivalent rating or higher. Use of a lower rated suction fitting could result in entrapment of the body which could result in serious injury including drowning.



Do not use or operate spa/swim spa if this suction fitting is missing, broken or not secured per instructions. The suction fitting is intended to prevent entrapment of the body. Use of the spa/swim spa with a missing, broken or improperly secured suction grate may result in serious personal injury including drowning.



When the spa/swim spa is in operation, suction is created at this fitting. Users of the spa/swim spa must be instructed not to come in contact with this fitting in such a way as to block its orifice. If a user of the spa/swim spa blocks this fitting with his/her body, serious personal injury or drowning may occur.

## IMPORTANT SAFETY INSTRUCTIONS



### WARNING - SUCTION ENTRAPMENT HAZARD

Suction in suction outlets and/or suction outlet covers which are damaged, broken, cracked, missing, or unsecured can cause severe injury and/or death due to the following entrapment hazards:

**Hair Entrapment:** Hair can become entangled in suction outlet cover.

**Limb Entrapment:** A limb inserted into an opening of a suction outlet sump/fitting or suction outlet cover that is damaged, broken, cracked, missing, or not securely attached can result in a mechanical bind or swelling of the limb.

**Body Suction Entrapment:** A negative pressure applied to a large portion of the body or limbs can result in an entrapment.

**Evisceration/Disembowelment Entrapment:** A negative pressure applied directly to the intestines through an unprotected suction outlet sump or suction outlet cover which is damaged, broken, cracked, missing, or unsecured can result in evisceration/disembowelment entrapment.

**Mechanical Entrapment:** There is potential for jewelry, swimsuit, hair decorations, finger, toe, or knuckle to be caught in an opening of a suction outlet cover resulting in mechanical entrapment.

## VGB SUCTION SAFETY & MAINTENANCE INSTRUCTIONS

---

### TO REDUCE THE RISK OF ENTRAPMENT HAZARDS:

- Never use a spa/swim spa if any suction outlet component is damaged, broken, cracked, missing, or not securely attached.
- Replace damaged, broken, cracked, missing, or not securely attached suction outlet components immediately.
- It is recommended that suction components be inspected at least monthly.
- Replace the suction within 7 years from the installation date. Contact your dealer or local service center for quoting and scheduling this required maintenance. This is a mandated regulation and is not part of nor covered by the spa/swim spa warranty.

**NOTE:** Always review entire safety and maintenance information before beginning maintenance. Contact Master Spas for Suction Installation information for complete suction assembly replacement.

# GLOSSARY OF SWIM SPA TERMINOLOGY

---

Your new swim spa features a variety of jets. All jets, regardless of style, return the water to the swim spa. Air is mixed with the water by using the air controls (if equipped) creating a vigorous massage. Water flow is adjusted by simply turning the outer face of most jets. Your swim spa may have a combination of pulsating, rotating, dual pulsating and directional adjustable jets. Here are some terms and definitions to help get you acquainted with your swim spa.

## 1. THERAPY JETS

Located throughout the seats of the swim spa to offer a variety of therapy combinations.

## 2. NECK JETS (if equipped)

Located above the normal water level to provide massaging action to the back of the neck.

## 3. SHOULDER JETS (if equipped)

Located above the normal water level to provide massaging action to the shoulders.

## 4. MASTER BLASTER® FOOT THERAPY JET (if equipped)

Large jet with several fixed nozzles located in the bottom of the swim spa near the floor to provide excellent massage to the feet.

## 5. JET DIVERTER VALVE\* (if equipped)

Located on the top flange of the swim spa, this large valve physically diverts the flow of water from one group of jets to another. Be sure that no sand or particles are brought into the swim spa as they will cause the diverter to seize up. It is best to turn the diverter valve only when the pump is turned off.

## 6. WATER FEATURE VALVE\* (if equipped)

Located on the top flange of the swim spa, this smaller valve adjusts water flow to the waterfalls and/or water features in your swim spa.

**NOTE:** When the swim spa is not in use, this valve should be turned mostly shut (not completely shut) to prevent the water features from allowing water to hit the cover while it is closed. If left mostly open, water may hit the cover and possibly run out of the swim spa causing water loss.

## 7. AIR CONTROL VALVE\*

These smaller valves are located around the top of your swim spa. You may increase or decrease the force of your jets by opening or closing the air control valves. Each air control valve will typically function 1 to 2 groups or seats of jets in the swim spa. When not in use, the air controls should be kept in the closed position as the air being introduced into the water can tend to cool the water and increase the dissipation rate of sanitizer levels.

## 8. TOPSIDE CONTROL PANEL\*

You may safely control swim spa functions from inside or outside your swim spa using the Topside Control Panel. This panel is used to control the water temperature, pumps, the swim spa light, automatic filtration cycles and other advanced functions. The digital display will give you a constant temperature readout and will notify you in case of certain malfunctions. Several user programmable functions are also available.

## 9. AUXILIARY BUTTON/PERSONAL KEYPAD CONTROL\* (if equipped)

Some swim spa models may have an additional button/keypad which allows the user to control components of the swim spa while being away from the main panel.



Personal Keypad Control



Auxiliary Button

\*NOTE: See Pump Diagrams in the back of this manual for location of valves, controls, and jets.

# GLOSSARY OF SWIM SPA TERMINOLOGY

## 10. ACCESS PANELS

These are the skirt panels located around all four sides of the swim spa. All of the skirt panels are removable should service be required. Master Spas recommends at least 3 feet of space be provided around the swim spa.

## 11. EQUIPMENT ACCESS PANEL

This is the skirt panel located on the seating end of the swim spa, or access panel “A”.. This area houses the majority of components responsible for the swim spa’s operation. This includes the pumps, heater, swim spa control system, ozonator (if equipped), and LED light system (if equipped). Pump and equipment placement may vary by model.

**NOTE:** On Challenger 18D Pro models, equipment will be found underneath panel “E”.

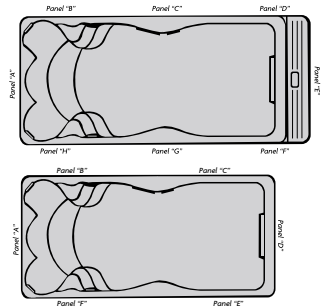

## 12. FILTER LID

This lid fits over the filter area and weir gate to cover the filters. Remove filter lid to access filters for maintenance. For models equipped with a telescoping filter housing, simply lift up to remove this floating assembly to access the filter. At low speed water flow or when the filtering/heating pump is off, the telescoping part of the filter assembly will float at or near the waterline. At high speed water flow, it will be drawn downward. See Accessing Filters in the Regular Maintenance Procedures section for detailed instructions on filter assemblies.

## 13. WEIR GATE

The weir gate is the horizontal door located in front of the filters that helps keep debris trapped in the filter area.

## 14. SWIM SPA CONTROL SYSTEM

This houses the wiring and electrical components necessary to operate the swim spa.

## 15. SWIM SPA HEATER

This is an electric heater housed in a stainless steel tube. It is thermostatically controlled and equipped with high-limit temperature safety shut-off sensors.

## 16. SLICE VALVES

These valves are used by service personnel to shut off water to the heating system (heater and pump plumbed to the heater) so that the swim spa water does not need to be drained if the swim spa requires service to the heating system (varies by model).

**NOTE:** Slice valves must be completely open during normal operations.



*Slice Valve and Pump Union*

## 17. MAIN THERAPY PUMP

This produces water flow through the main jets in the swim spa. The first pump may be operated on two speeds (varies by model). Low speed (if applicable) will produce efficient water circulation during filtration, heating of the swim spa water, and gentle jet action. High speed provides maximum jet action. The main pump is controlled by the “Jets” or “Jets 1” button on the Topside Control Panel.

## GLOSSARY OF SWIM SPA TERMINOLOGY

---

### 18. SECONDARY THERAPY PUMP

This produces water flow through 1 to 2 groups or seats of jets in the swim spa. The second pump operates similar to the main pump and is controlled by the “Jets 2” or “Aux” button on the Topside Control Panel.

### 19. THIRD THERAPY PUMP (if equipped)

This produces water flow through 1 to 2 groups or seats of jets in the swim spa. This is controlled by the “Jets 3” button on the Topside Control Panel.

### 20. CIRCULATION PUMP (if equipped)

This produces water flow through the heater in the swim spa and provides the water flow necessary to actuate the ozone injector. This energy efficient pump runs 24 hours for efficient filtration and heating.

### 21. PUMP UNION

This connects the plumbing and pump together. These are used to help relieve possible pump air locks or for service personnel to easily service the pumps.

### 22. HEATER UNION

These are used by service personnel to easily service the heater.

### 23. SWIM SPA LIGHT

The on/off control for the lighting in your swim spa is located on the topside control panel near the therapy seats.

### 24. EXERCISE/SWIM JETS (H2X Swim Spas)

These large jets are grouped at the end of your swim spa to offer water flow for exercising against. A jet diverter valve may control the flow for these jets.

### 25. SWIM SPA JUNCTION BOX (MP Swim Spa Only)

The internal junction box for connecting your electrical service(s) to the swim spa is located behind and accessible by removing access panels “B” and “A”.

### 26. PROPULSION SYSTEM ACCESS (MP Swim Spa Only)

The propulsion control system of the MP Swim Spas is located behind the skirt panel designated as “E” in the access panels drawing. The propulsion motor, propulsion control pack, and pulleys for the system are located in this area.

### 27. PROPULSION SYSTEM CONTROL PANEL (MP Swim Spa & H2X Challenger Models Only)

You may safely control the speed of the propulsion system or variable speed swim jets from the inside of your swim spa by using the touchscreen control panel mounted in the swim area. This control panel is used to turn the water flow for exercising on and off and to adjust the intensity. This control panel may be safely used from inside or outside of the swim spa to adjust the water flow.

## THE ADVANTAGES OF ECOPUR® CHARGE

---

# ECOPUR® CHARGE

MASTER CORE TECHNOLOGY

The EcoPur® Charge\* is made from Master Spa's patented filtration fabric. This fabric is wound tightly into a nautilus master core, creating a catalytic cell. The nautilus fabric cell is encased by a unique "spring core" that allows for maximum flow and water "charging". As water comes in contact with the EcoPur® Charge Master Core, a chemical reaction causes zinc and copper hydroxides to form in controlled amounts. Like Mother Nature, when controlled releases of copper and zinc oxides are carried into the filtered water, they kill bacteria and provide hostile conditions for algae and fungal growth. Using EcoPur® Charge helps reduce the amount of chemicals needed, therefore safeguarding the swim spa's plumbing and equipment because pipes are protected against the corrosive effects of chlorine. EcoPur® Charge Master Core Technology is another exclusive design by Master Spas.

### FEATURES

- Releases Sanitizing Copper & Zinc Oxides
- Reduces Water Soluble Heavy Metals
- Controls Scale, Bacteria and Algae
- Safeguards the Swim Spa's Plumbing
- Reduces Use of Chemicals
- Helps Prevent Damage to Swimwear



\*PATENTS PENDING

# THE ADVANTAGES OF ECOPUR® CHARGE

---

## ECOPUR® CHARGE INSTALLATION

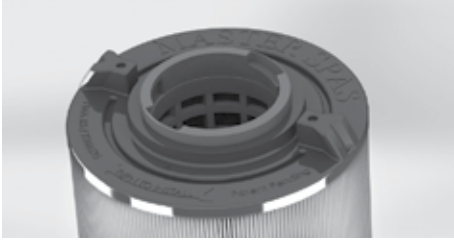

Master Spas Outer Filter\*



EcoPur® Charge\*

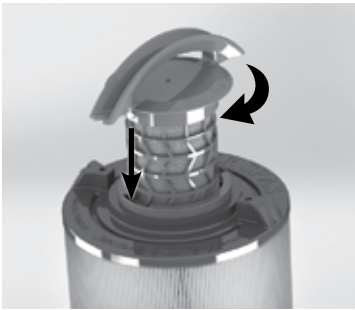

Turn Clockwise to Lock

### STEPS FOR INSTALLATION

1. Insert EcoPur® Charge in to outer filter.
2. Twist EcoPur® Charge clockwise to lock in place while holding on to outer filter. When snapped in to locked position, EcoPur® Charge handle aligns with molded points on outer filter.

**NOTE:** EcoPur® Charge should be replaced every 6 months. Initial snap in fit of inner EcoPur® Charge to outer filter may be tight, especially if both are new.

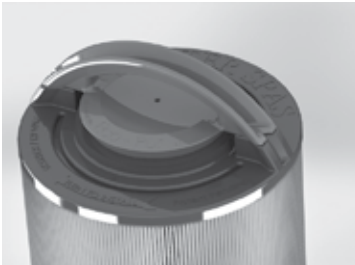

\*PATENTS PENDING

Before jumping into Water Maintenance, here are some terms to help you.

- 1. PARTS PER MILLION (PPM):** This is a form of measurement used in most pool or swim spa chemical readings. Best described as any one million like items of equal size and make up, next to one unlike item, but of equal size. This would be one part per million.
- 2. TOTAL ALKALINITY:** Measures substances in your water such as hydroxides, carbonates and bicarbonates. When at the proper levels, these elements keep your water from clouding and growing bacteria, as well as prevent the inner workings of your swim spa from deteriorating or forming scale. TA also helps to stabilize pH. The higher the TA level (as long as it is within the recommended range), the less likely the pH is to change. With low alkalinity, the pH will fluctuate and be harder to control. With high alkalinity, it becomes extremely difficult to change the pH.
- 3. PH OR POTENTIAL HYDROGEN:** This indicates the acidity or basicity of the water. The goal is to have a neutral, stable pH to prevent swim spa damage and unhealthy conditions. Low pH levels can corrode metals, etch or stain fiberglass or acrylic, cause unsanitary conditions that irritate the eyes or skin and destruct the total alkalinity of the water. High pH can cause cloudy water, eye or skin irritation, scale formation and poor chlorine or bromine efficiency. Note that the chemicals you are using to sanitize and clean your swim spa can also lower or raise the pH level in the water. Unfortunately, there are lots of variables to preventing high pH in your swim spa.
- 4. SHOCKING:** By shocking the water in your swim spa, you remove organic compounds from the water, kill bacteria, remove bromamines or chloramines and reactivate the bromides in the swim spa for cleaner water. You should shock your water once a week, after heavy bather use or any time free chlorine levels test lower than total chlorine levels. To do this, either add oxidizer/non-chlorine shock to burn off the chloramines or add extra chlorine to raise the chlorine level. Oxidizer/non-chlorine shock acts by releasing oxygen in the water, which serves a similar function as chlorine. An advantage to using this type of shock is that the water is safe to enter after 15 minutes of the application and excessive sanitizer (chlorine) levels do not occur. However, an oxidizer/non-chlorine shock doesn't disinfect the water for bacteria. If you use chlorine to shock, you must wait until the total chlorine reading is at a level safe to reenter the water.
- 5. SEQUESTERING:** This can be defined as the ability to form a chemical complex which remains in solution, despite the presence of a precipitating agent (i.e. calcium and metals). If the minerals and metals in water are not sequestered, they can cause a reaction, turning the water brown, red, orange or green depending on the minerals and metals present in your water. It is important to add a sequestering agent when adding water to your swim spa and even on a regular basis (if bottle instructions recommend doing so). Common names for sequestering chemicals are: minquest, stain and scale control, metal-x, spa defender, spa metal gone, etc.
- 6. FILTRATION:** Filters are necessary to remove particles of dust, dirt, algae, etc., that are continuously entering the water. If the swim spa is not operated long enough each day for the filter to do a proper job, this puts a burden on the chemicals, causing extra expense. Filtration time will depend on the water capacity, pump and filter size and, of course, bather load. Spare filter cartridges should be kept on hand to make it easy to frequently clean the cartridge without the need for a long shut down. This will also allow the cartridge to dry out between usages, which will increase the cartridge life span as much as twice. Replace the cartridge when the pleats begin to deteriorate. Cartridge cleaning should be done a minimum of once a month. More often with a heavy bather load. See Cleaning Your Filter Elements in the Regular Maintenance section.



## WATER CHEMISTRY TERMS YOU SHOULD KNOW

---

7. **SANITIZERS:** Germs and bacteria enter the water from the environment and the human body; a sanitizer keeps the water balanced and safe to use. Either chlorine or bromine can be used as a sanitizer to create a healthy water environment.
- A. Chlorine:
1. Only one type is approved for swim spa use. Sodium dichlor which is granular, fast dissolving and pH neutral chlorine.
  2. Chlorine is an immediate sanitizer and will be added as needed to maintain free chlorine levels.
- B. Bromine
1. Two types of tablets:
    - a. Hydrotech
    - b. Lonza
  2. Bromine is a slow dissolve chemical and may take a few days to develop a reserve or reading in the water.
- NOTE:** Bromine use is not recommended with EcoPur<sup>®</sup> filters as it can hinder being able to maintain proper reserve/residual levels for maintaining sanitary conditions.
- WARNING:** Nonslip, Comfort Floor System is not compatible with bromine and will result in unwarranted deterioration of the material. Do not use bromine if your swim spa is equipped with this System.
8. **TOTAL DISSOLVED SOLIDS (TDS):** Materials that have been dissolved by the water, i.e. like what happens when you put sugar in coffee or tea.
9. **USEFUL LIFE OF WATER (IN DAYS):** Water should be drained at least once every 180 days. Useful life may vary by usage and bather load.
10. **DEFOAMER:** A chemical used to temporarily reduce foaming. Causes of foaming include body oils, cosmetics, lotions, surface cleaners, high pH or algae, as well as other organic materials. Low levels of calcium or sanitizer can also cause increased foaming. Note that you may need to physically remove the foam and/or drain all or part your water to remove or dilute the causes of the foam.
11. **CALCIUM HARDNESS:** This measurement tells you how much magnesium and calcium are in your water. However, calcium hardness can react with all of the chemicals, bacteria, dirt and other substances that your water dissolves and get thrown out of balance. Just like the other elements, calcium levels must remain balanced and need to be monitored or you run the risk of metal deterioration, water foaming or clouding and scale formation at the surface of your water.
- NOTE:** Always leave swim spa cover open for 15 minutes after adding chemicals to prevent the off gas from damaging your swim spa cover, swim spa pillows, stainless steel hardware and other critical parts.
12. **BIOFILM:** This is any group of microorganisms in which cells stick to each other and often these cells adhere to a surface (i.e. swim spa plumbing and shell). Biofilm can occur over time during the use of your swim spa.

# WHY ARE CHEMICALS IMPORTANT IN A SWIM SPA

---

## 1. EVAPORATION:

As water evaporates, only pure water evaporates, leaving the salts, minerals, metals, and any unused chemicals behind. Adding water adds more salts, minerals, and metals. In time, the water can become saturated with these dissolved solids and can cause stains or scale to form on the walls of the swim spa or a scale build up inside the equipment. Colored or cloudy water and possible corrosion of plumbing and fittings may also occur.

## 2. HEAT:

Heat causes much quicker evaporation and also will cause minerals and metals to precipitate out of solution.

## 3. AIR:

Dust and other airborne contaminants are introduced into the swim spa.

## 4. ENVIRONMENT:

The environment surrounding the swim spa can also impact the water quality. Items such as pollen, grass, sand, dirt, lawn fertilizer, airborne dust, insects, leaves, and pets can all affect the water quality of the swim spa.

## 5. BATHERS:

As the swim spa is used, bathers introduce contaminants to the water. Increased bather load, length of use and frequency will increase the amounts of contaminants added in to the water.

**NOTE:** The maintenance routines set forth in this manual may need to be adjusted depending on bather load and how much the swim spa is being used.

## WATER MAINTENANCE – RECOMMENDED RANGES

### WATER CHEMISTRY GUIDE

Before treating your water, refer to the Model Specifications section of this manual for the correct gallons of your swim spa, to ensure you are adding the correct amount of chemicals. The concentration of active ingredients in swim spa chemicals varies by manufacturer, so always consult chemical manufacturer's instructions. When adding swim spa chemicals, always spread them across the surface of the water while the pumps are running. See chart below for recommended ranges.

BS EN 17125:2018

PARAMETER	VALUE <sup>A</sup>
Water Clarity	Clear view of the bottom
Color of Water	No color should be observed <sup>b, c</sup>
Turbidity in FNU/NTU	max. 1,5 (preferably less than 0,5)
Nitrate concentration above that of fill water (in mg/l)	max. difference of 20 compared to the fill water concentration
Total organic carbon (TOC) (in mg/l) <sup>d</sup>	max. 4,0
Redox potential against Ag/AgCl 3,5 M KCl in mV	min. 650
pH value <sup>e, f</sup>	6,8 to 7,6
Free active chlorine (without cyanuric acid) (in mg/l)	0,3 to 1,5 <sup>g</sup>
Free chlorine used in combination with cyanuric acid (in mg/l)	1,0 to 4,0 <sup>g</sup>
Cyanuric acid (in mg/l)	max. 100 <sup>h</sup>
Combined chlorine (in mg/l)	max 0,5 <sup>i</sup> (preferably close to 0,0 mg/l)
Bromine (in mg/l)	2,0 to 4,0 <sup>g</sup>

When using alternative/additional disinfectants other appropriate parameters may be considered.

<sup>a</sup> Consult national regulations and guidelines for any deviations.

<sup>b</sup> Natural water sources may introduce water colouration.

<sup>c</sup> Intentional water colouration is excluded.

<sup>d</sup> When using organic compounds this value may be higher.

<sup>e</sup> Subject to the flocculant(s) used (if any).

<sup>f</sup> When pH is greater than 7,5 the free active chlorine is less than 50 %.

<sup>g</sup> Temporary exceeding due to manual dosage and low water volume to user ratio is acceptable, provided the health of the user is not compromised.

<sup>h</sup> If national regulations allow > 100 mg/l then a suitable treatment should be applied (e.g. dilution).

<sup>i</sup> If national regulations allow > 0,5 then a suitable treatment should be applied (e.g. dilution)

**NOTE:** The Indicative physical and chemical parameters when using chlorine disinfectant outlined in this manual are specified to comply per EU regulation (BS EN 17125:2018). Regulatory agencies in countries outside of the EU may require different values than what is outlined here. If the swim spa is installed in a country outside of the EU, check with your local regulatory body for recommended chemical levels in your area. Improper use of chemicals may result in unsanitary and unsafe water conditions as well as unwarranted discoloration, degradation, damage and other imperfections of the swim spa surface and components.

 **WATCH HOW-TO VIDEOS:** [masterspas.com/video-tutorials](https://masterspas.com/video-tutorials)

## START UP STEPS

1. Your swim spa should be filled with fresh tap water using a Pre-filter, which can be obtained from your local Master Spas dealer. This Pre-filter will help remove many of the minerals existing in the water, which will make adjusting the water balance easier after a new fill. Never use more than 50% softened water when filling the swim spa.
2. During the initial filling of the swim spa, add a sequestering agent to combat suspended minerals in the water. The agents are sold under many different names such as Mineral Clear or Metal Protect. Always follow the instructions listed on the bottle and allow water to circulate and filter for at least 30 minutes (or per bottle recommendations) before adding any other chemicals.
3. Test water for pH, total Alkalinity, and Calcium hardness. There are two different methods you can use to test your water.

**TEST STRIPS:** The pads on these thin strips react by changing colors when you dip them in the swim spa water. To avoid faulty test results, use care when removing a testing strip from the packaging. Open the package and shake one strip out into your hand, avoiding contact if possible with the remaining strips. Seal the container immediately so the remaining strips are not exposed to moisture. Dip the test strip into the water and follow the instructions supplied with test strips as instructions may vary. Note the colors on your testing strip and compare these to the key found on the packaging to determine whether elements are neutral, too high or too low.

**TESTING KIT:** When using a testing kit, you will be examining an actual water sample from your swim spa, rather than a strip. Be careful to follow the instructions on your kit, filling the container to the appropriate level and then dropping the instructed liquid into the container. Compare the new color of your water to the key provided with the kit to determine how to proceed. Depending on which kit you purchase, it can test for each one of these elements: total alkalinity, pH, chlorine, bromine and calcium hardness.

4. Adjust pH and total Alkalinity (TA) utilizing the directions on the chemical bottles. Wait 15 minutes, test and adjust if necessary.
5. It may be necessary to retest and add additional chemicals to get to the proper levels.
6. Add concentrated chlorinating granules (sodium Dichlor-s-triazinetreone) on initial start up to begin sanitizing the swim spa water, according to directions on chemical bottle. Bathers should not enter the swim spa until the chlorine drops to a safe level, refer to Water Chemistry Guide in this section. It is important not to add the chlorinating granules until the pH, alkalinity and calcium hardness have been adjusted to their proper levels.

**NOTE:** See the Model Specifications section of this manual for the correct gallons of your swim spa, to ensure you are adding the correct amount of chemicals. When adding chlorine or non-chlorine shock/oxidizer always spread it across the water while the pumps are running. The concentration of active ingredients in swim spa chemicals varies by manufacturer.



**WATCH HOW-TO VIDEOS:**  
[masterspas.com/video-tutorials](https://masterspas.com/video-tutorials)

▶ **WATCH HOW-TO VIDEOS:** [masterspas.com/video-tutorials](https://masterspas.com/video-tutorials)

### BEFORE EACH USE

Test the swim spa water for proper sanitation levels and adjust accordingly to the proper levels outlined in the Water Chemistry Guide, found in the Water Maintenance – Recommended Ranges section. Appropriate levels should be present before use of the swim spa. Bathers should not enter the swim spa if the chlorine levels are outside of the safe, recommended ranges.

### AFTER EACH USE

Test water and treat accordingly to maintain proper pH and free chlorine levels for continued sanitary conditions after use. The amount of people using the swim spa (and duration of use) will deplete chlorine levels and can cause free chlorine to test below total chlorine, resulting in a more frequent need to use an oxidizer/non-chlorine shock treatment.

### 3 TIMES A WEEK

Test the water. Adjust sanitizer, pH and Alkalinity accordingly, following directions on the chemical manufacturer's bottle. If free chlorine level measures less than total chlorine level, additional non-chlorine shock/oxidizer treatment is necessary.

### ONCE A MONTH

Soak your regular filter elements overnight in a container with swim spa Filter Cleaner and then rinse with clean water. For best results, allow the filter to dry before re-inserting. (The EcoPur® element should never be cleaned in a filter cleaner. Just rinse with water.) When cleaning filters, be sure to never have the pumps (including the circulation pump) running without the filters in place. Failure to do so may result in debris being drawn into the pumps causing unwarranted damage. See Cleaning Your Filter Elements in the Maintenance section of this manual for more information.

### EVERY 180 DAYS

Drain and refill your swim spa with fresh water, install a new EcoPur® element, clean the regular filter, and repeat start up procedure. The regular filter should be replaced at least once every year. Over time and bather use, biofilm buildup can occur. Chemical products are available to help remove biofilm and should be used periodically before draining.

### AS NEEDED

If the water looks hazy, make sure pH is in the proper range and treat with chlorinating granules to maintain free chlorine levels. Treat with non-chlorine shock (oxidizer shock) if free chlorine is less than total chlorine. Always refer to the chemical manufacturer's dosage recommendations listed on the container. Free chlorine levels should be maintained per the Water Chemistry Guide.

A defoamer may be used when excessive foaming occurs. Over use of a defoamer will result in cloudy, milky water. These are general recommendations for water maintenance that may vary by usage and bather load. Depending on bather load and frequency of use, drain and refill times may vary as well as the frequency of cleaning your filters.

### USE ONLY SWIM SPA CHEMICALS

Do not use chemicals designed for use in swimming pools.

With a swim spa you are working with a small volume of hot water compared to a large volume of relatively cool water in a swimming pool. Because of this, chemicals will have a shorter life span and bacteria can grow more quickly than in a swimming pool. A swim spa is less forgiving than a pool and requires that whatever is put into it have a pH as close to neutral as possible. That is why only chemicals made for swim spas should be used. Always refer to the chemical manufacturer's dosage recommendations listed on the container.

# WATER MAINTENANCE – TROUBLESHOOTING GUIDE

EN 17125

▶ WATCH HOW-TO VIDEOS: [masterspas.com/video-tutorials](https://masterspas.com/video-tutorials)

PROBLEM	POSSIBLE CAUSES	HOW TO FIX IT
<b>CHLORINE ODOR</b>	Excessive chlorine	Shock water with oxidizer/non-chlorine shock treatment
	Low pH	Adjust pH if necessary
<b>WATER ODOR</b>	Low levels of sanitizer	Adjust sanitizer level with chlorinating granules
	pH out of range	Adjust pH if necessary
	Bacteria or algae growth	If sanitizer has already been adjusted, it may be necessary to perform a system flush
<b>CLOUDY WATER</b>	Dirty filters or inadequate filtration	Clean filters with filter cleaner and adjust filtration
	Unbalanced water chemistry	Test and adjust chemistry levels
	Old water	Drain, clean inner shell and refill with filtered water
<b>CLOUDY AND GREEN WATER</b>	Total alkalinity levels are low	Use a pH increaser
	Sanitizer levels are low	Apply oxidizer/non-chlorine shock treatment and adjust sanitizer
<b>CLEAR GREEN WATER</b>	High iron or copper content	Use a sequestering agent
	Sanitizer levels are low	Apply oxidizer/non-chlorine shock treatment
<b>BROWN WATER</b>	High iron or manganese level	Use a sequestering agent
<b>FOAMING</b>	High levels of body oils, lotions, soap, etc.	Add small amount of defoamer, an enzyme product and check water chemistry
	Low calcium hardness	Use a calcium hardness increaser
	Unbalanced water chemistry	Test and adjust chemistry levels
<b>EYE OR SKIN IRRITATION</b>	Unsanitary water	Adjust water chemistry according to testing results
	Total chlorine level above 5 ppm	Apply oxidizer/non-chlorine shock treatment
	Poor sanitizer/pH levels	Adjust pH level as necessary
<b>SCUM DEPOSITS AT WATERLINE</b>	Body oils and dirt	Use multi-purpose cleaner to clean swim spa surface and add enzyme product to swim spa water
<b>CHALKY, WHITE SCALE DEPOSITS</b>	Minerals present in the water and lack of sequestering agent use	When swim spa is drained, use a multi-purpose cleaner or white vinegar and scrub with a soft cloth
<b>PITTING OF METAL FIXTURES</b>	Low pH or total alkalinity	Check water chemistry and adjust

**NOTE:** Please refer to the Water Maintenance - Recommended Ranges section to review recommended chemical levels.

## REGULAR MAINTENANCE PROCEDURES

EN 17125

▶ WATCH HOW-TO VIDEOS: [masterspas.com/video-tutorials](https://masterspas.com/video-tutorials)

**NOTE:** These maintenance procedures are the responsibility of the swim spa owner to perform. These procedures are not covered by the swim spa warranty.

### DRAINING YOUR SWIM SPA

Due to the physical size of the swim spa, we recommend draining your swim spa with a submersible sump pump. Draining your swim spa with a conventional spa drain is not a reasonable option. When draining the Momentum 80 swim spa always drain the water from the spa side before draining the swim side. Your swim spa requires periodic draining and cleaning to ensure a safe, healthy environment. It is recommended that you clean your swim spa at least every 180 days. Heavy bather load will require cleaning it more often.

**NOTE:** If your swim spa required multiple electrical services, be sure to turn off breakers for all services powering the spa equipment. See model specifications and appropriate electrical requirements for your model or contact your electrician if you are not familiar with how your electrical was installed. A breaker or power cut off should always be within line of sight.

Caution and careful planning should be taken if draining in freezing temperatures to ensure the process is performed quickly and that the water is either refilled quickly again or winterization steps are immediately performed. Try to plan your normal draining maintenance during times when temperatures are above freezing. Excess water in the plumbing can freeze in a short time frame depending on temperatures and conditions. Water freezing within plumbing and components can result in freeze damage which is not warranted.

### STEPS FOR USING A SUMP PUMP\*

1. Carefully lower submersible pump with hose connected into the bottom of swim spa, taking care not scratch or gouge your swim spa shell.
2. Run the discharge end of the hose from your submersible pump to a desired location several feet away from your swim spa, where the water will drain away from foundation that the swim spa is resting on.
3. Plug in/turn on your submersible pump. Once it is no longer able to suck up any further water (indicated by a suctioning sound and water no longer coming out of the drainage hose), turn off/disconnect your submersible pump. If you plan to fully wipe down and clean your entire swim spa shell, use a shop vac to remove the remaining small pockets of water in the swim spa. \*Sump Pump is not provided with swim spa.

### SWIM SPA SURFACE CARE

- During use, always remove debris and pollutants that have settled in the water or built up on the swim spa surfaces as it occurs. These pollutants can cause growth of bacteria, algae, fungus or biofilm if left on the swim spa surface and potentially cause stains.
- Clean the swim spa shell, jets and other controls with a soft cloth and swim spa shell cleaner to help remove residue and buildup on the shell surface. For any remaining buildup, white vinegar or mild scale remover product may be necessary to use with a soft cloth for removal. Consult with your local Master Spas dealer for proper swim spa cleaning products.
- Rinse the cleaned surfaces with fresh water from your garden hose and wipe with a soft cloth as doing so will help to remove residual cleaning agents (as some may cause foaming to occur in the water once swim spa is refilled).
- Always use an approved insulating swim spa cover by Master Spas to cover your swim spa when not in use, especially in outdoor installations where the swim spa is exposed to weather conditions and sun. Constant, prolonged exposure and use of unapproved or non-insulating swim spa cover can result in damage to swim spa surface which would not be warranted.

### REFILL YOUR SWIM SPA

- If filling the Momentum swim spa, always fill the swim side of the unit before filling the spa side.
- Refer to the Water Maintenance Start-Up section for specific instructions.

## REGULAR MAINTENANCE PROCEDURES

▶ WATCH HOW-TO VIDEOS: [masterspas.com/video-tutorials](http://masterspas.com/video-tutorials)

**NOTE:** These maintenance procedures are the responsibility of the swim spa owner to perform. These procedures are not covered by the swim spa warranty.

### CLEANING JETS



The majority of jets in your swim spa can individually be turned on/off. If any of these jets become hard to turn, it will be necessary to remove the jet to clean it as grit/sand and mineral deposit may be present.

The jets in your swim spa can be removed for cleaning by turning them counter-clockwise until they release and then pulling out the jet.

**TO CLEAN JETS:** Place the jet(s) in a container, fully immerse in white vinegar. Let the jet(s) soak overnight and then rinse with water. It may be necessary to clean grit and deposits from the white jet body (mounted in the swim spa shell) by using a small bristled brush.



**EN 17125, Do not put finger in massage jet**

### CLEANING DIVERTER VALVES

Mineral deposits, grit and sand may get into the internal parts of the diverter valves over time.



The diverter valves may become difficult to turn or not turn at all.

**CAUTION – TURN OFF SWIM SPA BEFORE PROCEEDING WITH THIS MAINTENANCE.**

**FOLLOW THE STEPS BELOW:**

1. Remove the handle from the top of diverter valve by grasping the handle and pulling up with a rocking motion.
2. Turn the cap piece counter-clockwise. It may be necessary to put a clean towel over the cap and turn it with a wrench.
3. Once loose, the cap, internal rotor assembly and handle can be pulled up out of the white plumbing fitting.
4. Wipe down the internal rotor assembly that attaches to the cap and handle.
5. Soak the internal rotor assembly in white vinegar.
6. The inner wall of the white plumbing fitting should also be wiped down. If the surface of the white plumbing has become too abrasive, you can take wet, fine sandpaper and smooth it out.
7. Rinse the diverter internals. Inspect O-rings for cracking or swelling and apply silicone lubricant to them. Then reassemble.

**NOTE:** It is helpful to turn the diverter valve only when the pump is not on. Cleaning your diverter valve should occur every time you drain your swim spa. Refer to Draining Your Swim Spa in the Regular Maintenance Procedures section.



## REGULAR MAINTENANCE PROCEDURES

▶ WATCH HOW-TO VIDEOS: [masterspas.com/video-tutorials](http://masterspas.com/video-tutorials)

**NOTE:** These maintenance procedures are the responsibility of the swim spa owner to perform. These procedures are not covered by the swim spa warranty.

### CARE OF LAMINAR FLOW JETS

In order to keep your Laminar Flow Jets operating properly, follow these steps:

1. Turn off Laminar Flow Jets.
2. Remove outer ring by turning face counter-clockwise.
3. Either the whole Laminar Flow Jet Assembly pops out: Rinse it out and inspect it.

Or, if only the outer ring comes off: Remove internal Jet insert with a pair of needle nose pliers and inspect it.



OR



4. Clean plastic diffuser at the back of the Jet insert or Laminar Flow Jet Assembly so all holes are free of debris.
5. Reinstall Jet insert or assembly and outer ring by pushing it in and turning it clockwise until it stops.



**EN 17125, Do not put finger in massage jet**

**NOTE:** To prevent premature failure of your swim spa cover and the possibility of water running out of the swim spa off the bottom of the cover, always turn Laminar Flow Jets down so that they do not hit the cover when the cover is closed. You do not want to completely turn jets off. Doing so may cause a build up of stagnant water in the water line if not used often.

### CLEANING YOUR FILTER ELEMENTS

The filter elements are one of the most important components of your swim spa. Not only are they essential for clean water; they also extend the life of the swim spa equipment and help avoid unnecessary water changes and re-heating. Your filter elements should be cleaned on a regular basis, at least once a month on average with normal usage. With heavy use, poor water quality and/or high dissolved solid content in water; the filters may need to be cleaned more often. It recommended to allow filter elements to fully dry after cleaning. For this reason, it is ideal to have a spare set of filters on hand for filter cleaning intervals.

1. Turn off the swim spa before servicing filters. Never leave to the swim spa running when removing the filters. Debris can be pulled into the plumbing system and cause unwarranted damage.
2. Remove any large or floating debris from the filter area. Next, match your filter housing to the following photos on the next page to finish steps for removing filter element(s).

## REGULAR MAINTENANCE PROCEDURES

**NOTE:** These maintenance procedures are the responsibility of the swim spa owner to perform. These procedures are not covered by the swim spa warranty.

### Filter Weir with Single Filter Front Access

When lifting the housing, be careful not to lift too far, as you could break the floating weir door. Damage to weir door is not warranted.

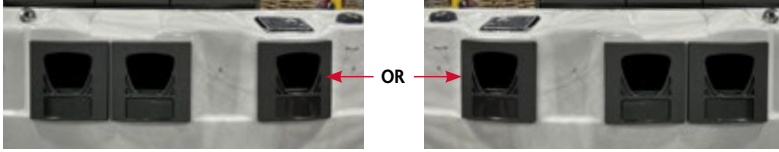

*Slide Faceplate Up and Out Slowly to Remove*

**NOTE:** EcoPur 2-piece set is typically placed in filter housing that stands off from the other 2. If Mast3rPur circulation system present, this position offers optimal benefits of having EcoPur.

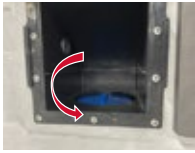

*Turn Filter Counter-clockwise to Remove*

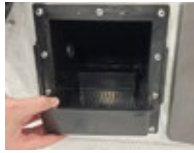

*Pull Up on Plastic Skimmer Plate to Remove*

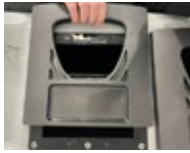

*Let the Weir Door to fall back towards the filters when removing the filter housing.*

### Filter Weir with Top Access



*Remove Filter Lid*



*Turn Filters Counter-clockwise to Remove*

**NOTE:** EcoPur 2-piece set is typically placed in filter housing that stands off from the other 2. If Mast3rPur circulation system present, this position offers optimal benefits of having EcoPur.

### Vane Teleweir Filter Housing



*Pull Up to Remove Floater Assembly*



*Turn Filters Counter-clockwise to Remove*

## CLEANING YOUR FILTER ELEMENTS (continued)

3. With a garden hose, spray each element under pressure. Monthly, the standard filter elements should be soaked in a filter cleaner. Do not soak EcoPur® element in a filter cleaner. The EcoPur® element should only be rinsed with fresh, clean water if necessary. Check with your Master Spas dealer for details on cleaning and/or filter replacement recommendations.
4. The EcoPur® element should be replaced every 6 months. The standard filter should be cleaned regularly and will typically last approximately 1 year. Bather load, usage and water quality will effect the longevity of the filters and require more frequent cleaning or replacement.

## REGULAR MAINTENANCE PROCEDURES

---

▶ WATCH HOW-TO VIDEOS: [masterspas.com/video-tutorials](https://masterspas.com/video-tutorials)

**Note:** These maintenance procedures are the responsibility of the swim spa owner to perform. These procedures are not covered by the swim spa warranty.

### CLEANING THE CLEAR ACRYLIC DIVIDER (Momentum)

- The surface should be first flushed with clean water to remove loose abrasive particles. The clear acrylic sheet should then be gently sponged with a mild soap/water solution and finally rinsed with clean water. Care must be taken not to leave any of the soap residue in the swim spa as it could cause the swim spa water to foam during operation.
- Drying can be done with a clean soft cotton towel. Avoid hard rough cloths or paper towels since they can put fine scratches on the acrylic surface.
- Do not use any aggressive solvents (lacquer thinner, gasoline, acetone and etc.) on the clear acrylic sheet. These products can cause damage to the sheet that may not be visible until days or weeks later.
- Window glass cleaning compounds are not recommended. Cleaning products that contain any type of abrasive material should not be used.

### CARE OF ACRYLIC LED LIT HANDRAILS

Special care should be given to the Acrylic LED Lit Handrails so that they maintain their attractive appearance and durability for the life of your swim spa.

- During draining and cleaning process, wipe down the handrails with a mild dishwashing detergent or spa shell surface cleaner and a clean soft cloth, applying light pressure. Rinse with clean water and blot dry with a dry soft cloth. Remove as much residual soap as possible from swim spa to prevent foaming when refilled.
- Scale and mineral (i.e. calcium) buildup can be removed using white vinegar and soft cloth. Rinse with clean water and blot dry with a soft cloth.
- Maintain the surface gloss of the acrylic and lessen scratches by occasionally polishing with a plastic cleaner and polish. Apply a thin even coat with a clean soft cloth and polish lightly with cotton flannel. Then wipe with damp, soft cloth. This is recommended to do after swim spa is drained for cleaning.
- To remove deeper scratches, first sand lightly with 400-grit wet sandpaper, using plenty of water and rinsing the sandpaper often. Next, follow the steps for applying plastic polish above (if necessary, do so when swim spa is drained).

**NOTE:** Do not use window cleaning spray, kitchen scouring compounds, or solvents such as acetone, gasoline or lacquer thinner. The clear handrail does have limited resistance to Isopropyl alcohol up to 50% grade. If used, limit the exposure time to prevent damage and do not expose to more than 50% grade.

### CARE OF YOUR SWIM SPA PILLOWS

- Your swim spa pillows should be rinsed periodically to remove chemical residue. This helps improve pillow lifespan and slows down deterioration of the pillows (i.e. discoloring, becoming stiff and flaking of the material).
- If the swim spa will not be used for a period of time, the pillows could be removed and rinsed to prolong their life.

**NOTE:** Do not cover the swim spa for 15 minutes after adding chemicals as the off gas can cause damage.

## REGULAR MAINTENANCE PROCEDURES

---

▶ WATCH HOW-TO VIDEOS: [masterspas.com/video-tutorials](https://masterspas.com/video-tutorials)

**NOTE:** These maintenance procedures are the responsibility of the swim spa owner to perform. These procedures are not covered by the swim spa warranty.

### CARE OF STAINLESS STEEL

Master Spas uses stainless steel in a number of our swim spas. Its lasting beauty and resistance to corrosion make it an excellent material for handrails and jets faces. With the proper care it will keep its luster for many years. All stainless steel can corrode given the right circumstances so we have provided a guide to help you keep the stainless components in your swim spa looking nice. Stainless steel derives its ability to resist corrosion by forming a very thin transparent coating on the surface when exposed to oxygen. This coating can be damaged by abrasive materials such as steel wool, sand paper, and other cleaning materials that are abrasive. Chlorine salts, sulfides, or other rusting metals can also erode this thin coating exposing the metal to corrosion. The best defense to combat corrosion on stainless steel components in your swim spa is make sure that it is kept clean and free of any chemical build up.

#### Always:

- Clean frequently with fresh, clean water.
- Remove any rust spots as soon as they appear with vinegar or a brass, silver, or chrome cleaner.
- Use a good car cleaning wax for extra protection.
- Leave cover removed for at least 15 minutes after adding chemicals to the swim spa water.

#### Never:

- Clean with mineral acids or bleaches, steel wool or any other abrasive materials.
- Leave in contact with iron, steel any other metals.
- Close the cover immediately after adding chemicals to the water.

**NOTE:** Failure to take proper care of the stainless steel components could result with them rusting. Rusting is not covered by the warranty.

**NOTE:** Do not cover the swim spa for 15 minutes after adding chemicals as the off gas can cause unwarranted damage. Larger dosages can require longer lengths of time to off gas. It is recommended to check swim spa water more frequently to allow small dosages be added as necessary versus large dosages being added less often.

### CARE OF YOUR SWIM SPA CABINET

The swim spa cabinet is made from a UV resistant material. The cabinet requires only periodic cleaning with a stream of water from a garden hose. If necessary, use mild soap and water with soft cloth to wipe down cabinet surface. Rinse thoroughly.

## REGULAR MAINTENANCE PROCEDURES

---

 WATCH HOW-TO VIDEOS: [masterspas.com/video-tutorials](https://masterspas.com/video-tutorials)

**NOTE:** These maintenance procedures are the responsibility of the swim spa owner to perform. These procedures are not covered by the swim spa warranty.

### CARE OF YOUR SWIM SPA COVER

Always cover your swim spa when not in use with an approved insulating swim spa cover by Master Spas. Keep the swim spa cover on to minimize heat loss during heating of the swim spa between uses (but not while it is being used). This will greatly reduce energy consumption and will cause swim spa water to heat more rapidly. Water loss and chemical usage will also be reduced.

- Ensure the cover is fitted tightly, as per manufacturer's instructions to maximize insulation.
- Be sure to lock down all straps on the cover after each use.
- Do not allow swim spa to sit uncovered in direct sunlight. The heat and UV from direct sun exposure can cause damage to exposed shell surfaces of the swim spa as well as damage or discoloration of the swim spa controls and fittings.
- See cover manual instructions for detailed instructions on proper cover care. Clean the cover at least once a month using mild soap and water. Rinse thoroughly with fresh water to remove pollutants and soap residue. If mold/mildew staining has occurred (particularly on bottom of the cover), a mixture of bleach and water used with a soft cloth may be necessary. Thoroughly rinse with fresh water after cleaning.
- Keep cover open for 15 minutes after adding chemicals to prevent excessive off gas buildup and damage.
- When the swim spa is being used, the cover should be placed in a clean, dry area, otherwise it can pick up dirt and bacteria. Covers should not be put on wooden tables or wooden decking because of the risk of bleaching the wood.
- The use of a cover lift accessory or other device ensures the cover will not come into contact with the ground and retains its cleanliness (particularly the surface in close proximity to the swim spa water surface). The cover should be stored in an appropriate location, where it cannot be damaged, or cause damage.

**NOTE:** If your swim spa is going to be left empty for prolonged periods, do not place cover directly on the swim spa's surface (closed and sealed). Instead, place a 1" block of high density foam between the cover and the swim spa. This allows for ventilation to help reduce mold and mildew from occurring while the swim spa is empty.

**NOTE:** The cover warranty is not part of the limited warranty provided with the swim spa. It is provided through the cover manufacturer and may not be through Master Spas. Check the tags and labeling on your cover to verify manufacturer and refer to the manufacturer's care, maintenance and warranty information. Your dealer can help provide you with these details.

**NOTE:** Always use the water feature controls to turn down the water flow so that the water features do not hit the cover when the cover is closed. Do not turn them all the way off.

### CARE OF YOUR OZONE SYSTEM

The ozone hose and check valve connecting between the ozone generator and ozone injector should be inspected and/or replaced, if necessary, every 12 months. Depending on conditions of the air which is being brought in to the ozone generator, the ozone hose and check valve can wear more rapidly. This regular maintenance is not covered under the swim spa warranty. We recommend that your Master Spas Dealer or service organization be contacted to perform this type of maintenance.

## REGULAR MAINTENANCE PROCEDURES

---

▶ WATCH HOW-TO VIDEOS: [masterspas.com/video-tutorials](https://masterspas.com/video-tutorials)

**NOTE:** These maintenance procedures are the responsibility of the swim spa owner to perform. These procedures are not covered by the swim spa warranty.

### CARE OF EXERCISE EQUIPMENT

The included\* exercise equipment accessory package makes it easy to exercise in your own backyard. This kit is located in a box inside your swim spa cabinet near where you found your owner's manual and manufacturer warranty documents. There are shell mounted clips that are used to fasten the rowing equipment to the swim spa. These clips are located along the sides of your swim spa next to the grab rails that are placed around the perimeter of the swim area. Be sure to read the included materials for instructions on utilizing this equipment in your swim spa.

**CAUTION:** Do not leave exercise equipment inside the swim spa when not in use. Rinse equipment with fresh water and dry after uses for best longevity. Do not leave exercise equipment outside exposed to sun and UV. Failure to follow the above guidelines could result in injury.

**CAUTION:** Inspect exercise equipment before each use for deterioration and unsafe conditions. Do not use if significant deterioration and unsafe conditions exist (i.e. cracking and break down in bungee strap material caused by use, water conditions and care). Replacement exercise kits can be purchased through your Master Spas dealer. Failure to follow the above guidelines could result in injury.

\*The exercise equipment package is not included from factory with some Therapool models. If you would like this package, please contact your local Master Spas dealer to purchase it.

# SWIM SPA TROUBLESHOOTING GUIDE

---

**NOTE:** For wiring outside of U.S. and Canada, GFCI may be referred to as a RCD (residual current device). Be sure all local electrical codes are followed.

## GFCI IS TRIPPING

A ground fault circuit interrupter (GFCI) is required by the National Electrical Code for your protection. The tripping of the GFCI may be caused by a component on the swim spa or by an electrical problem. Electrical problems include but are not limited to, a faulty GFCI breaker, swim spa component, power fluctuations, and/or improper wiring. If this is a new electrical service and GFCI installation, an instantly tripping GFCI may likely be caused by improper wiring of the load neutral from the GFCI to the swim spa. It may be necessary to contact an electrician if your Master Spas dealer recommends doing so.

## NOTHING ON THE SWIM SPA OPERATES

1. Check the control panel display for any messages. If there is a message, refer to the diagnostic section on that model swim spa. There, you will find the meaning of the message and what action is to be taken.
2. If there is no message on the control panel and the control panel is completely dark (off), try to reset the GFCI breaker.



*The GFCI should be located in a weather proof box within sight from the swim spa, but not close enough to reach from within the swim spa (consult NEC and licensed electrician).*

**NOTE:** If your swim spa requires 2 independent electrical services (shown in the Model Specifications and appropriate Electrical Requirements Configuration), be sure to check all breakers for your swim spa.

If the swim spa does not respond, or the GFCI breaker continues to trip, contact your local Master Spas dealer or service organization.

## SWIM SPA NOT HEATING

If the swim spas heater has failed, the majority of the time it will trip the GFCI breaker. If the swim spa is not heating and has not tripped the breaker, please follow these steps:

1. Check water set temperature at control panel to make sure it is set to desired temperature, above the current water temperature.
2. Check the “Heat Mode” that the swim spa is set in. The swim spa should be set in the Standard Mode or Ready Mode depending on the model. If Rest or Economy Modes are enabled it will change the way the swim spa heats and primarily only heat during the user programmed timing. See the swim spa control section for heating modes such as rest or economy programming details.
3. Check the control panel for heat indicator. If heat indication is on, wait a reasonable amount of time (at least 3-4 hours) to see if the water temperature is rising.
4. If heat indicator does not remain on, the system should be displaying a message indicating why it can't heat. Check the control panel for diagnostic messages. Refer to Spa Control Section titled System Related Messages. Follow steps to alleviate the message.
5. Reset power to the swim spa at GFCI breaker.
6. Check the control panel for heat indicator. If the heat indicator is on, wait a reasonable amount of time (at least 3-4 hours) to see if the water temperature is rising.
7. If swim spa is still not heating, contact your local Master Spas dealer or service organization.

## SWIM SPA TROUBLESHOOTING GUIDE

---

### WATER TEMPERATURE IS ABOVE SET TEMPERATURE (HEAT CREEP)

Because Master Spas swim spas are well insulated and built to meet stringent energy standards, heat creep can occur. This means that the measured temperature of the water in your swim spa is creeping up higher than the set temperature on your control panel. Heat creep can occur as outdoor temperatures become moderate to warm or when your filter cycle durations have been adjusted above the default settings. To help manage heat creep:

1. **Vent your cover.** This means placing a folded cloth about  $\frac{3}{4}$  inches (2 cm) thick under all four corners of the cover before you lock the cover down.
2. **Open your cover.** Opening the cover at night will also quickly cool the water down if desired. **NOTE:** Never leave a swim spa cover open and unsupervised.
3. **Open all air controls.** Temporarily leave the air controls open during cooler times of the day or night. Set your filtration cycles to run during this time as well.  
**NOTE:** If the heat creep issue has been resolved, close the air controls when not using the swim spa to reduce energy and chemical maintenance.
4. **Reduce the length of your filter cycles.** The default duration is generally 4 hours of filtering per day (either a duration of 2 hours that occurs twice per day or one 4-hour filter duration based on time of day).
5. **Visit your local Master Spas dealer for additional guidance.** Heat creep can happen on well-insulated swim spas, and is related to the environment where the swim spa is installed and equipment runtimes such as extended filter cycle durations (especially on systems using Therapy Pump 1 low speed for filtering and heating). This is not indicative that there is a problem with the swim spa.

### PUMP(S) DO NOT OPERATE

1. Press the “Jets” button on your control panel.

If you hear the pumps trying to operate:

- A. Check that all the slice valves are open.
- B. Pump may need to be primed.

Refer to Installation Instructions section. If you do not hear anything from the pump, contact your local Master Spas dealer or service organization.

**NOTE:** If the pump(s) had been operating for 15 minutes or longer prior to ceasing operation, it may be normal and simply related to mild or warmer temperature conditions and excessive internal temperatures occurring from prolonged pump run time. The spas are built to meet stringent energy efficiency standards and to run at full capacity during the 15 minute safety timeout periods. Operating pumps at high speed repeatedly beyond the 15 minute timeout can result in the pump motor getting too warm and shutting itself off to cool down. This would be seen by the control indicating the pump should be one still, but the pump has shut itself off internally. If this thermal cutout occurs, the pump will remain off for several minutes to cool. Once the equipment area and motor cool down, it would begin operating again.

### POOR JET PERFORMANCE

1. Make sure pump is operating.
2. Check that the water level is adequate (at least to minimum safe water level on sticker located near filter.)
3. Make sure the jets are open and the air controls are open.  
Refer to Glossary of Swim Spa Technology section.



# WINTERIZING & STORING YOUR SWIM SPA

---

## WINTERIZING YOUR SWIM SPA

Your swim spa is designed to be used year round in any type of climate.

However, if you decide you don't want to use your swim spa in the winter, you must drain it and follow the winterizing steps listed below.\*

**DISCLAIMER:** Master Spas does not recommend winterizing your swim spa. If you choose to do so, any damage that may result is not covered under the swim spa warranty.

1. Drain your swim spa. Refer to instructions in Regular Maintenance Procedures.
2. Use a shop vac to get all standing water out of your unit.
3. Remove access panels from equipment area.
4. Loosen all pump unions.
5. Remove winterizing plug from face of the pump(s) where applicable.
6. Using your shop vac in a blowing mode, insert the hose into the nozzle of each jet and blow the trapped water from the lines into the interior of the swim spa. A non-toxic, RV water line type antifreeze can be used and added to jets in each seat around your swim spa to help prevent freeze damage from occurring. Be sure to thoroughly flush the system before startup.
7. After this is completed, use the shop vac to remove any standing water in the swim spa and in the equipment area.
8. Clean the swim spa with a soft cloth and a non-abrasive swim spa surface cleaner.
9. Replace access panels.
10. Cover the swim spa to prevent water from entering it and check the swim spa periodically to be sure no water is entering and accumulating. Swim spa covers are a great insulator but will allow some precipitation to enter the swim spa. For this reason, it is highly advised to also cover the swim spa with a water tight tarp while winterized. It is beneficial to keep the swim spa cover slightly gapped off the acrylic shell while winterized to allow air flow in to the shell area to reduce mildew/mold buildup caused by trapped moisture.

\* If you decide to winterize your swim spa, we recommend that you periodically check the swim spa throughout the winter to assure water is not entering the swim spa through or around the swim spa cover.

## STORING YOUR SWIM SPA

The swim spa shell should never be left unprotected and uninsulated while being stored. Clear plastic wrap or similar material should never be used to cover/protect the swim spa.

Prolonged, direct sun heat can damage the surfaces of the swim spa along with any components on the swim spa's surface. Always keep the swim spa covered and protected with an insulating swim spa cover. Resulting damage such as cracking in the shell surface, warping or discolored components on the swim spa would not be warranted.

An empty swim spa should never be exposed to temperatures below 0°F (-18°C) after delivery as extreme cold can cause shell damage. This includes storage and draining (winterizing). If your swim spa will be exposed to these temperatures, keep the unit filled and running. If you do not plan to use your swim spa, you can set the swim spa to the lowest temperature setting allowed by the control system while in Standard/Ready Mode.

Failure to adhere to these guidelines may result in unwarranted damage caused to the swim spa.

# MODEL SPECIFICATIONS

MODEL	LISTING NUMBER	SWIM SPA DIMENSIONS (In./cm)	ELECTRICAL REQUIREMENTS <sup>1</sup>	SEATING CAPACITY <sup>2</sup>	WATER CAPACITY <sup>3</sup> (gallons/m)	DRY WEIGHT <sup>4</sup> (lbs./kilos)	FULL WEIGHT <sup>5,6</sup> (lbs./kilos)	THERAPY PUMPS	CONTROL SYSTEM
INT MP FORCE D	1420	201" x 94" x 60" 511 x 239 x 153	*Spa Pack - 240V, 32A Propulsion - 240V, 32A	5	1935 / 7.32	2685 / 1218	19750 / 8959	2	MS81SPA
INT MP SIGNATURE D	8900	215" x 94" x 60" 547 x 239 x 153	*Spa Pack - 240V, 32A Propulsion - 240V, 32A	5	2275 / 8.61	2795 / 1268	22695 / 10295	2	MS81SPA
INT MP MOMENTUM D	1250A - Spa 1250B - Swim	231" x 94" x 60" 587 x 239 x 152	*Spa Pack - 240V, 32A *Swim Pack - 240V, 16A Propulsion - 240V, 32A	7 5 - Spa 2 - Swim	2325 / 8.80 2050 / 7.76 - Swim 275 / 1.04 - Spa	3700 / 1678	24390 / 11063	3	Spa - MS81SPA Swim - MS6013XE

<sup>5</sup>See Electrical Requirements section for further details.

<sup>1</sup>Total bather capacity in swim spa. The number of bathers in swim spa should never exceed indicated seating capacity. Depending on swim spa size, water level and bather displacement, full seating capacity may not be achievable. Do not allow additional bathers to enter if bather displacement results in water levels overflowing or reaching the swim spa controls (air controls, diverters, swim spa topside control and etc.) as this will result in water leaking out of the swim spa shell and potentially in to the equipment area.

<sup>2</sup>Full weight based on dry weight of swim spa, max seating capacity of swim spa, assumed average weight per person of 185 pounds and estimated water weight of 8.34 pounds per gallon. Rounded up in increments of 5.

<sup>3</sup>Manufacturing tolerances along with other factors can result in variance in actual swim spa weight. If weight is a critical figure necessary for delivery, or final installation, we suggest a minimum of 15% be added to the listed weight when planning delivery or installation.

<sup>4</sup>Default Minimum Electrical Requirement as Configured from Manufacturing. See Electrical Requirements Section for Electrical Hook-Up by Control System.

Swim spa installation is simple when properly planned. It is important that you read the following information carefully and consult with your Master Spas dealer.

- 1. ACCESS:** The actual dimensions of your new swim spa will determine the amount of space that is needed in moving the swim spa from curbside to its final installation area. Be sure to consider and measure side yard dimensions, gates, doors, overall room dimensions and vertical obstructions such as ceilings, roof overhangs, balconies and overhead cables. Any other space limiting obstacles such as stairs, trees, and shrubs must also be evaluated. Consideration should also be taken to ensure there is convenient water supply for filling your swim spa (review national and local regulations). The desired location for swim spa might require use of a crane. Please be sure to contact and review these site and installation plans with your Master Spas dealer prior to delivery. It is also good to consider these access requirements for ease of removing the swim spa from the premises in the event it is necessary to do so.
- 2. SURFACE/PAD REQUIREMENTS:** When your new swim spa is filled with water and bathers, it may weigh as much as several tons. It is imperative that the base beneath the swim spa can support the entire weight. The swim spa must be on a uniformly firm, continuous, and level surface. The recommended foundation is a concrete pad with a minimum thickness of four inches with steel reinforcement bars crossed throughout the pad.

### IMPORTANT

Consult experts and/or local authorities to review and comply with all local and national laws and regulations relating to childproofing, safety barriers, lighting and any other safety requirements at site. When installing your swim spa indoors, on a wood deck, roof or balcony, load requirements need to be evaluated before installation. It is also good to consider location and position of swim spa as well as surfaces and foundation to minimize noise disturbance as much as possible. You should speak with a qualified contractor or your local building department to confirm that your surface is adequate for supporting the swim spa and conforms to these guidelines.

All sides of the swim spa must be accessible for regular maintenance or in the event that service is needed. Periodical maintenance checks require entry into the equipment bay. When possible, it is wise planning for the future to leave 3 feet of access to all sides of the swim spa in the event your swim spa requires maintenance. Your swim spa warranty does not cover the cost of providing access for service.

### GENERAL CONSIDERATIONS FOR OUTDOOR INSTALLATION

Again, proper planning will increase your total enjoyment factor with your new swim spa. Listed below are some additional items to consider when planning your installation.

- Local building codes (if applicable)
- Power cable
- Appropriate materials and drainage around the swim spa to handle water presence and runoff
- Consider local environmental conditions, such as ground water and risk of frost
- In cold climates, an insulating ground cloth can be installed between foundation and swim spa to minimize heat loss
- How swim spa will complement landscaping and vice versa
- View from inside swim spa and view of swim spa from inside of home
- Exposure to sunlight and shading from trees
- Privacy
- Getting to swim spa from the house and back
- Proximity to dressing rooms and bathrooms

## SITE PREPARATION / GENERAL GUIDELINES

---

### GENERAL CONSIDERATIONS FOR INDOOR INSTALLATION

Installing your swim spa indoors creates an entirely different set of considerations.

- Storage for swim spa chemicals
- Work with your Master Spas dealer and contractor to insure all local building, electrical and plumbing codes are met
- Plan for proper flooring and floor drains around your swim spa to drain off excess water runoff that will occur during normal use and for draining and cleaning your swim spa
- Proper room ventilation and dehumidification
- Finished materials in your swim spa room should also be capable of withstanding increased humidity and moisture

### GUIDELINES FOR PARTIALLY OR FULLY RECESSED INSTALLATION

Swim spas manufactured by Master Spas are designed to be installed in a variety of settings. One of which is installing below grade. Should a swim spa be installed below the level of the site drainage system (below grade), a system for preventing water collecting and pooling must be designed based on the requirements of the local authority having jurisdiction. The drainage system must be designed based on things such as rainfall, water runoff, splashing, draining the swim spa, etc., that could potentially feed the below grade area with water. When located in designated floodways, additional attention to maximum water load entering the area below grade must be addressed to prevent water from accumulating below grade at all times. It is generally recommended that the swim spa be installed above grade because the swim spa is not designed to be submerged in water. When a proper drainage system is designed and proper ventilation is planned based on the characteristics of the site, installing the swim spa below grade is an accepted method of installation.

- The unit is self-supporting when placed on a surface designed to support the full load of the swim spa (see Surface/Pad Requirements). Do not backfill with sand, gravel, or earth. Doing so will void the warranty.
- Plan for complete drainage so that water accumulation drains away from the swim spa perimeter and standing water never reaches the electrical equipment.
- Plan for appropriate ventilation to remove moisture accumulation and to prevent equipment from overheating.
- Provide a minimum of 3 feet service area around the perimeter of the unit. Site access issues are not covered by the product warranty.
- The unit is not designed to be submerged in water. Water entering the equipment area creates many hazards and resulting damage will not be covered by the product warranty.
- Make sure that the surroundings do not create any additional hazards.
- Surfaces placed around the unit should also be evaluated for walking/slipping hazards from standing water. Proper drainage is vital to the installation of a below grade installation.
- Check all building, electrical, and plumbing codes with the authority having jurisdiction to ensure that your installation is in compliance with all local codes.
- Additional consideration needs to be made when installing unit in designed floodways.
- Verify that site specific drainage systems such as down spouts are not going to feed the area below grade.
- Below grade drainage system needs to be evaluated based on area specific rainfall. One size does not fit all so an analysis by a qualified, local engineer to ensure proper drainage of all sources of water is a must when installing below grade.

# SITE PREPARATION/GENERAL GUIDELINES

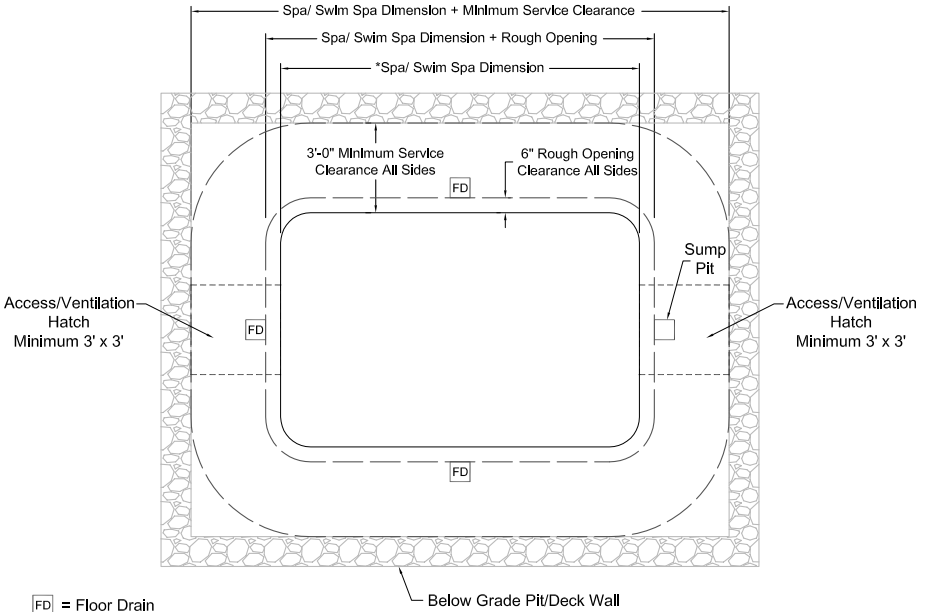

FD = Floor Drain

[ ] = Access/ Ventilation Hatch ( Min. 3' x 3')

\* = See "Model Specification" section of Owner's Manual for applicable Spa/ Swim Spa dimensions.

# ELECTRICAL REQUIREMENTS

## ALL MODELS

**NOTE:** Electrical requirements by model is shown in Model Specifications. Only electrical configurations pertaining to the models referenced in this manual are shown.

### ELECTRICAL REQUIREMENTS

#### HAVE YOUR ELECTRICIAN READ THE FOLLOWING INFORMATION BEFORE INSTALLATION BEGINS

Electrical connections made improperly, or the use of wire gauge sizes for incurring power which are too small, may continually blow fuses in the electrical equipment box, may damage the internal electrical controls and components, may be unsafe and in any case will void your warranty.

It is the responsibility of the swim spa owner to ensure that electrical connections are made by a qualified electrician in accordance with codes regulated by the authority having jurisdiction at the time of installation.

These connections must be made in accordance with the wiring diagrams found inside the control box and in this manual. This equipment has been designed to operate on and requires 230V, 50Hz service. Make sure that power is not applied while performing any electrical installation. A bonding lug for bonding copper wire has been provided on the electrical equipment pack to allow connection to local ground points. The ground wire must be at least 8 AWG (8.36mm<sup>2</sup> copper wire unless local or state codes require a heavier gauge wire) and must be connected securely to a grounded metal structure such as a metallic cold water pipe. The supply wiring to the swim spa must utilize a symmetrically grounded system. The swim spa must not be wired to electrical systems utilizing no ground (IT) or TN-C grounding. Be sure to have a licensed electrician examine and ensure proper grounding is provided. See chart on next page for wire size conversion. All Master Spas equipment packs are wired for 230 VAC only. The only electrical supply for your swim spa must include a switch or circuit breaker to open all non-grounded supply conductors to comply with BS7671 (or other local jurisdiction code or law). The disconnect must be readily accessible to the swim spa occupants, but installed at least five feet from the swim spa. Residual Current Device (RCD) must be used to comply with this manual, BS 7671, or any local electrical code or law requirements. A residual current is a current leak from any one of the supply conductors to ground. An RCD is designed to automatically shut off power to a piece of equipment when a ground fault is detected.

Route the cable into the equipment area for final hook-up to terminals inside the control pack or junction box. The swim spa must be hooked up to a “dedicated” breaker(s) and RCD. The term “dedicated” means the electrical circuit for the swim spa is not being used for any other electrical items (patio lights, appliances, garage circuits, etc.). If the swim spa is connected to a non-dedicated circuit, overloading will result in “nuisance tripping” which requires resetting of the breaker switch at the house electrical panel.

202012

## ELECTRICAL REQUIREMENTS

### 230 VOLT 50 HZ – RESIDUAL CURRENT DEVICES (RCDs)

A residual current device (RCD) is the generic term for a device that monitors the current in the line conductor and the neutral conductor in an earthed system.

In a circuit that's operating properly, the vector sum of the live and neutral current values added together will be zero. Current flowing to earth, due to a line earth fault, will return via the earth conductor, and regardless of load conditions, will be registered as a fault. This current flow will give rise to a residual current that will be detected by the device. If the residual current exceeds the rated sensitivity of the RCD, it will automatically activate a tripping of the faulty circuit.



Two Pole RCD



Four Pole RCD

#### Typical specifications are as follows:

Residual Current Devices (RCDs) range

Sensitivity – from 10 to 30mA

Voltage – 2 poles: 230V; 3/4 poles:  
230/400V

Connection capacity

- 25A: 6/10 mm<sup>2</sup> (flexible/rigid cable)

- 40,60A: 16/25 mm<sup>2</sup>

- 80,100A: 35/50 mm<sup>2</sup>

Total Ampere Rating of Power System	Minimum Wire Size Use Copper ONLY with 90° C Insulation	Ampere Rating of RCD Circuit-Breaker
0 A to 16 A	#12 AWG / 3.31 mm <sup>2</sup>	20
16 A to 20 A	#10 AWG / 5.26 mm <sup>2</sup>	25
20 A to 24 A	#10 AWG / 5.26 mm <sup>2</sup>	30
24 A to 28 A	#8 AWG / 8.36 mm <sup>2</sup>	35
28 A to 32 A	#8 AWG / 8.36 mm <sup>2</sup>	40

**CAUTION** – Actual wiring of RCD will vary by manufacturer of RCD. Improper wiring of RCD may result in permanent damage to swim spa control pack. Repair/replacement of swim spa system box is not covered under warranty when damage results from improper wiring. Actual wire attachment points on the swim spa control pack may vary. Always refer to the wiring diagram inside the swim spa control pack for proper power connection.

# ELECTRICAL REQUIREMENTS

## MS40E/MS81SPA E HOOK-UP

### AS MANUFACTURED – SINGLE SERVICE (Figure 1)

Single Service, TN and TT Electrical Systems (1x13 Amp, 1x16 Amp or 1x32 Amp)\* 3 Wires (1 Line + 1 Neutral + 1 Protective Earth). Protective Earth wire (Green/Yellow) must be connected to system ground terminal as marked.

Heat Disable dip switches (Switch Bank S1, A2-A4) must be evaluated to prevent the swim spa maximum ampacity from exceeding the service maximum ampacity. When wiring swim spa to electrical requirements as configured from factory, dip switch settings should not be changed from factory settings.\*

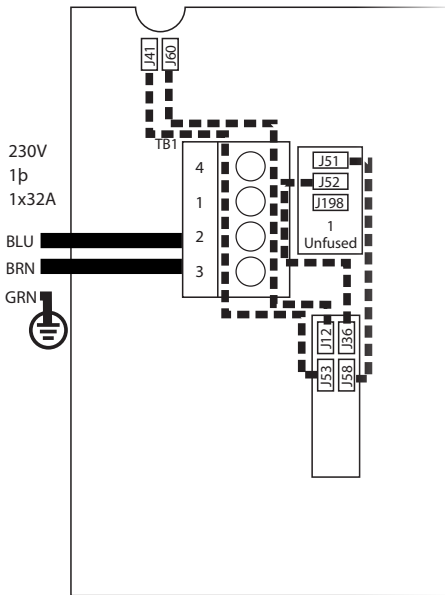

Figure 1

\*Wiring must be sized to swim spa specification. Swim spa rated maximum ampacity cannot exceed the service maximum ampacity. This does not represent an option to the Installer. See Model Specifications page for electrical requirements by swim spa model.

**CAUTION – RCD will vary by manufacturer of RCD. Improper wiring of RCD may result in permanent damage to spa control pack. Repair/replacement of spa system box is not covered under warranty when damage results from improper wiring. Actual wire attachment points on the Spa Control Pack may vary. Always refer to the wiring diagram inside the Spa Control Pack for proper power connection.**



# ELECTRICAL REQUIREMENTS

## MS40E/MS81SPA E HOOK-UP

### OPTIONAL HOOKUP – 3 SERVICE (Figure 2)

3-Phase Service, TN and TT Electrical Systems 5 Wires (3 Lines + 1 Neutral + 1 Protective Earth)\*. Protective Earth wire (Green/Yellow) must be connected to system ground terminal as marked.

1. Remove all jumper wires as indicated by dotted lines in Figure 1 (previous page).
2. Only reinstall jumper wires as indicated by dotted lines in Figure 2.

**IMPORTANT – EACH SERVICE MUST INCLUDE A NEUTRAL WIRE, WITH A LINE TO NEUTRAL VOLTAGE OF 230VAC.**

Heat Disable dip switches (Switch Bank S1, A2-A4) must be evaluated to prevent the swim spa maximum ampacity from exceeding the service maximum ampacity per line (L1, L2 & L3).

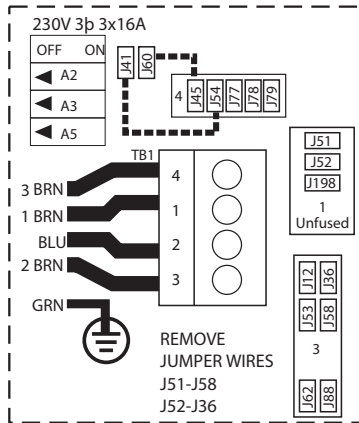

Figure 2

\*Wiring must be sized to swim spa specification. Swim spa rated maximum ampacity cannot exceed the service maximum ampacity. This does not represent an option to the Installer. See Model Specifications page for electrical requirements by swim spa model.

**CAUTION – RCD will vary by manufacturer of RCD. Improper wiring of RCD may result in permanent damage to spa control pack. Repair/replacement of spa system box is not covered under warranty when damage results from improper wiring. Actual wire attachment points on the Spa Control Pack may vary. Always refer to the wiring diagram inside the Spa Control Pack for proper power connection.**

# ELECTRICAL REQUIREMENTS

## MS6013XE HOOK-UP

### AS MANUFACTURED – SINGLE SERVICE (Figure 1)

Single Service, TN and TT Electrical Systems (1x13 Amp, 1x16 Amp or 1x32 Amp)\* 3 Wires (1 Line + 1 Neutral + 1 Protective Earth). Protective Earth wire (Green/Yellow) must be connected to system ground terminal as marked.

Heat Disable dip switches (Switch Bank S1, A2-A4) must be evaluated to prevent the swim spa maximum ampacity from exceeding the service maximum ampacity. When wiring swim spa to electrical requirements as configured from factory, dip switch settings should not be changed from factory settings.\*

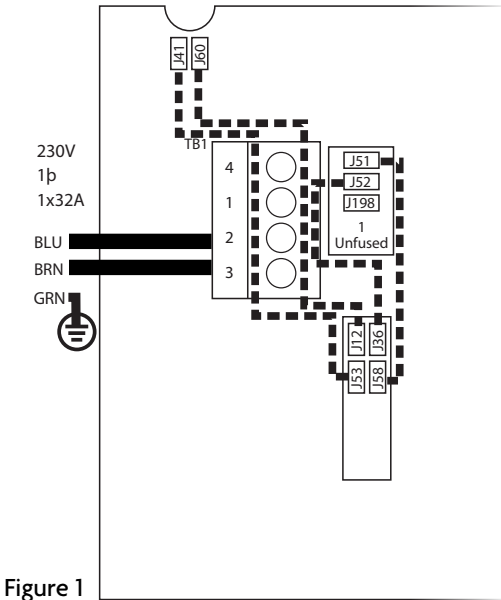

Figure 1

\*Wiring must be sized to swim spa specification. Swim spa rated maximum ampacity cannot exceed the service maximum ampacity. This does not represent an option to the Installer. See Model Specifications page for electrical requirements by spa model.

**CAUTION – RCD will vary by manufacturer of RCD. Improper wiring of RCD may result in permanent damage to spa control pack. Repair/replacement of spa system box is not covered under warranty when damage results from improper wiring. Actual wire attachment points on the Spa Control Pack may vary. Always refer to the wiring diagram inside the Spa Control Pack for proper power connection.**

# ELECTRICAL REQUIREMENTS

## MS6013XE HOOK-UP

### OPTIONAL HOOKUP – 3 SERVICE (Figure 2)

3-Phase Service, TN and TT Electrical Systems 5 Wires (3 Lines + 1 Neutral + 1 Protective Earth)\*. Protective Earth wire (Green/Yellow) must be connected to system ground terminal as marked.

1. Remove all jumper wires as indicated by dotted lines in Figure 1 (previous page).
2. Only reinstall jumper wires as indicated by dotted lines in Figure 2.

**IMPORTANT – EACH SERVICE MUST INCLUDE A NEUTRAL WIRE, WITH A LINE TO NEUTRAL VOLTAGE OF 230VAC.**

Heat Disable dip switches (Switch Bank S1, A2-A4) must be evaluated to prevent the swim spa maximum ampacity from exceeding the service maximum ampacity per line (L1, L2 & L3).

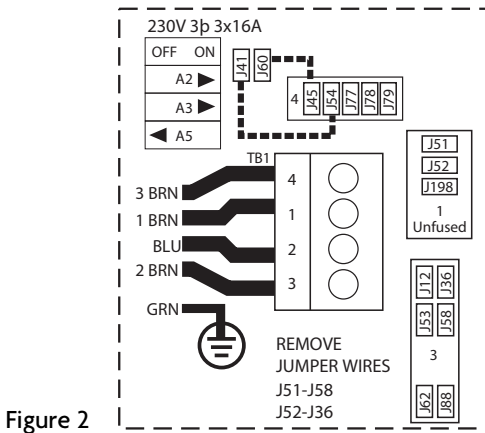

Figure 2

\*Wiring must be sized to swim spa specification. Swim spa rated maximum ampacity cannot exceed the service maximum ampacity. This does not represent an option to the Installer. See Model Specifications page for electrical requirements by spa model.

**CAUTION – RCD will vary by manufacturer of RCD. Improper wiring of RCD may result in permanent damage to spa control pack. Repair/replacement of spa system box is not covered under warranty when damage results from improper wiring. Actual wire attachment points on the Spa Control Pack may vary. Always refer to the wiring diagram inside the Spa Control Pack for proper power connection.**

# INITIAL SWIM SPA SETUP

EN 17125

▶ WATCH HOW-TO VIDEOS: [masterspas.com/video-tutorials](https://masterspas.com/video-tutorials)

## SETUP STEPS

1. Put swim spa in final position that allows for access to equipment and swim spa components. Master Spas recommends that at least 3 feet of space be provided around all sides of the swim spa for access. This provides adequate space for regular maintenance and service.
2. Remove skirt panels "A" and "B" to access the electrical connections inside the swim spa. The junction box (MP Swim Spas Only), swim spa control system(s) and majority of the equipment in your swim spa can be accessed by removing access panels "A" and "B". See Equipment Access Panel in Glossary of Swim Spa Terminology for diagram.
3. Be sure all pump and heater unions are secure. Each pump has 2 unions and the heater has 2 unions. A newly delivered swim spa may have loose unions caused in transporting the swim spa. Check that all slice valves are open, in the up position. The slice valves may become closed during transportation of the swim spa.



*Slice Valve and Pump Union*

4. Fill swim spa to the minimum water level label indication located on the swim spa shell near the filter area or at least 1' above the filters or filter housing opening. We recommend filling the swim spa through the filter area to help reduce air locks from occurring in the filter and heating pump. When filling or topping off water, do not exceed the maximum fill level indication on the water level label. On the Momentum swim spa model with a clear acrylic divider, it is recommended that the swim side be filled first and then the spa side. When draining the swim spa always drain the spa side before draining the swim side.

**NOTE:** In below freezing temperatures, caution should be taken when planning to install a swim spa and fill it with water. As it takes time for the water to fill the swim spa and reach the proper minimum water level, the water entering the various plumbing lines and equipment may begin to freeze up when done in winter weather conditions. This could result in pumps being seized until thawed or other potentially worse freeze damage occurring to the equipment and plumbing lines.

5. Turn on power to the swim spa. If your swim spa is equipped with two electrical supplies, make sure that they are both turned on. The swim spa will go through its priming mode. This lasts approximately 5 minutes. The purpose of the priming mode is to help insure that the jet pumps have been primed with water and are ready to operate. It may be necessary in some instances to bleed air from the jet pumps in your swim spa. If after the priming mode the swim spa pumps run but do not move water, the pump may have an air lock.

Due to the nature of water flow and hydro-therapy pumps, please be advised that air locking of pumps may occur. Master Spas has taken measures to reduce the possibility of this, but it still may occur, especially after filling the swim spa. This is not a service covered by the warranty and service charges may apply. See next page for instructions on how to relieve an airlock.

6. Be sure the adjustable jets in your swim spa are open by turning the face of the jet. Most of the jets in your swim spa are adjustable and removable by turning the face of the jet.

## INITIAL SWIM SPA SETUP

---

7. It may be necessary to bleed air from the pump(s) in your swim spa if, after start up, your swim spa pumps are turning on and off but you do not have water flow from the jets in your swim spa.

Due to the nature of water flow and hydro-therapy pumps, please be advised that air locking of pumps may occur. Master Spas has taken measures to reduce the possibility of this, but it still may occur, especially after refilling a swim spa. This is not a service covered under warranty and service charges may apply.

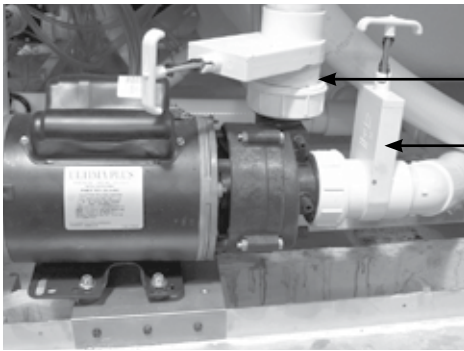

*Airlock*

To relieve an airlock situation, loosen the pump union on the discharge of the pump. This pump union is indicated by an arrow in the picture. Water should leak out of the union once the air has been removed. Tighten the union and test the pump for proper operation. Repeat this process if needed.

8. Adjust water chemistry according to the instructions provided in the Water Maintenance section.
9. Your swim spa water will heat approximately 1 degree Fahrenheit per hour (approximately 0.5 degrees Celsius) with the cover placed snug and secured on the swim spa. This timing will vary depending on the size of the swim spa and ambient conditions.
10. Step into the soothing waters of your Master Spa swim spa!  
Relax and enjoy.



**WATCH HOW-TO VIDEOS:**  
[masterspas.com/video-tutorials](https://masterspas.com/video-tutorials)

# SWIM SPA CONTROLS - ICON SPA TOUCH

## THE MAIN SCREEN

EN 17125



# SWIM SPA CONTROLS - ICON SPA TOUCH

## THE MAIN SCREEN

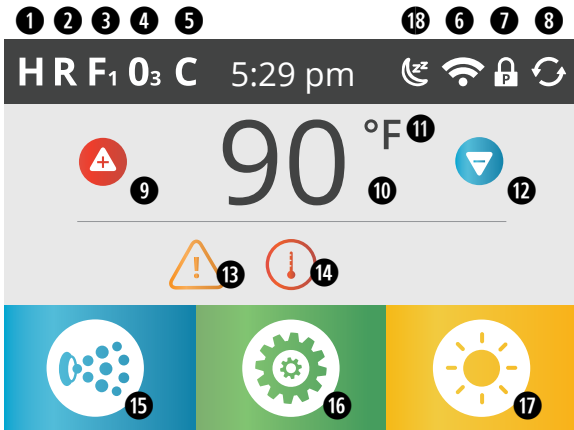

## SWIM SPA STATUS

Important information about swim spa operation can be seen on the Main Screen. Various features and main menus can be accessed from this screen. The actual water temperature can be seen and the Set Temperature can be adjusted. Time-of-Day, Ozone and Filter Cycle status is visible, along with other messages and alerts. The selected Temperature Range is indicated in the upper left corner. The Swim Spa Equipment Control Icon in the bottom left corner will bubble if any pump is running. A Lock icon is visible if the panel or settings are locked.

## ICON SPECIFICATIONS

- |   |                                     |
|---|-------------------------------------|
| ❶ H = High Temperature Range              | ❶❶ Current Water Temperature        |
| ❷ R = Ready Mode                          | ❶❷ Temperature Scale (F/C)          |
| ❸ F <sub>1</sub> = Filter Cycle 1 Running | ❶❸ Set Temperature Down             |
| ❹ O <sub>3</sub> = Ozone Running          | ❶❹ Message Waiting Indicator        |
| ❺ C = Cleanup Cycle                       | ❶❺ Heat Indicator                   |
| ❻ Wi-Fi Indicator                         | ❶❻ Swim Spa Equipment Control Icon  |
| ❼ Lock Indicator Icon                     | ❶❼ Settings Icon                    |
| ❽ Invert Screen                           | ❶❼ Light Icon = Turns On/Off        |
| ❾ Set Temperature Up                      | ❶❽ Instant Sleep Mode (if equipped) |

**NOTE:** After 30 minutes the display will automatically go into sleep mode, which turns the display off. This is normal operation. Touch anywhere on the screen to wake the control panel up.

**NOTE:** Water accumulating on the touch screen along with whether skin is dry or water soaked will result in misinterpreted inputs and/or reduced touch input capabilities. It is ideal to keep a dry towel nearby for best experience and use of touch panels.

# SWIM SPA CONTROLS - ICON SPA TOUCH

## THE MAIN SCREEN

### ICON SPECIFICATIONS

1. **H** = High Temperature Range **L** = Low Temperature Range
2. **R** = Ready Mode **R<sup>2</sup>** = Ready And Rest Mode **R<sup>2</sup>** = Rest Mode
3. **F<sub>1</sub>** = Filter1 Mode **F<sub>2</sub>** = Filter2 Mode **F<sub>12</sub>** = Filter1 and 2 Mode
4. **O<sub>3</sub>** = Ozone is Running. If you don't see the icon that means the Ozone is OFF.
5. **C** = Cleanup Cycle is Running. If you don't see the icon that means the Cleanup Cycle is OFF.
6. **Wi-Fi Icon** just indicates that the optional Wi-Fi module is connected to the swim spa system. It does not indicate signal strength.
7. **Lock Icon:** When displayed, indicates the panel is in a locked mode.

There are 2 lock icons that can be shown on the title bar of most screens. A lock icon with an 'S' **S** means that a settings lock has been applied. It is shown on screens that are affected by the settings lock. And a lock icon with a 'P' **P** means the Panel has been locked. If both settings and panel are locked, only the panel lock will show since it overrules just settings being restricted. When the panel is locked, the Settings Menu Screen will only show items not affected by that lock (System Info and Lock Screens).

To unlock or lock a setting or panel lock, you press the corresponding icon that is locked and then press and hold the word "Lock" in the title bar for 5+ seconds until the text and icon change to the opposite state.

8. **Invert (or flip) Screen**
9. **Set Temperature Up:** Adjust set temperature higher.
10. **Current Water Temperature:** Displays current water temperature.
11. **Temperature Scale:** Indicates if the temperature is in **°F = Fahrenheit** or **°C = Celsius**.
12. **Set Temperature Down.** Adjust set temperature lower.
13. **Message Waiting Indicator.** The Message Waiting Indicator will show one of the following icons:

**!** = Critical Error (Swim spa can't function until it's fixed)

**!** = Normal Error or Warning

**🔔** = Reminder Message

**i** = Information Message

Touch the Indicator to go to a Message Screen which shows the message.

Some messages will include the "Call for Service" text as it requires a service technician to fix the problem. If the panel is locked and a message alert appears, you will be taken to the UNLOCK screen before you can clear the message.

Touching the Error/Warning/Reminder/Info Icon on the Message Screen will take you to the System Information Screen to allow for troubleshooting over the phone or for a field service tech to better understand what is going on. Exiting the System information Screen will take you back to the Message Screen in that situation.







14. **🔥** = Heat Indicator. Indicates the heating process and when the swim spa heater is on.



# SWIM SPA CONTROLS - ICON SPA TOUCH

## THE MAIN SCREEN

### ICON SPECIFICATIONS

15.  = **Swim Spa Equipment Control Icon**. Brings up a screen where the swim spa jets or other equipment can be controlled. While on the Swim Spa Equipment Screen, you can press a Jets button once for low speed, and if applicable, press it again for high speed.
16. **Setting Icon:**  = **Settings is Active**  = **Settings is Inactive**  
Takes you to Settings Menu Screen, where the available specific features that can be adjusted by the control panel can be modified.
17.  = **Light is turned ON**  = **Light is turned OFF**  = **Light is Disabled**
18.  = **Instant Sleep Mode Icon**: This is to force the screen to sleep immediately versus letting it time out after a few minutes. This can be used to help prevent splashing and water on the screen from causing undesired input on the touch panel (if equipped).

### NAVIGATION

Navigating the entire menu structure is done by touching the screen.

The screen selections indicated below can be selected to take you to additional menus. Touch one of these to enter a different screen with additional controls.

Most menu screens time out and revert to the main screen after 30 seconds of no activity.

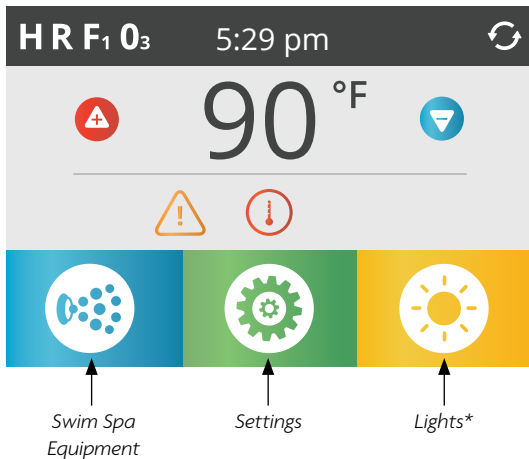

*\*Only if Light System is equipped.  
Options vary by model.*

# SWIM SPA CONTROLS - ICON SPA TOUCH

## THE MAIN SCREEN

### MESSAGES

At the bottom of the screen, at certain times an indicator may appear showing that a message is waiting. Touch this indicator to go to the Message Display Screen. On that Screen some of the messages can be dismissed.

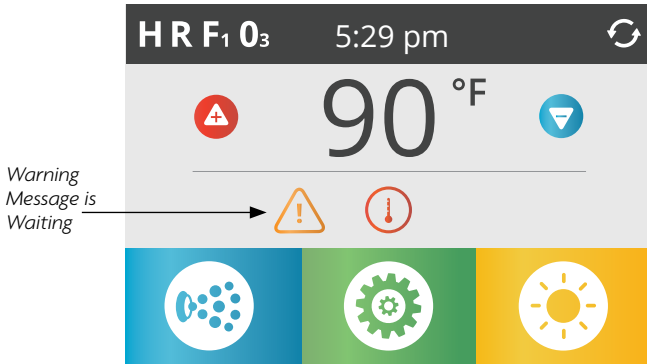

# SWIM SPA CONTROLS - ICON SPA TOUCH

## THE SET TEMPERATURE AND LIGHTS

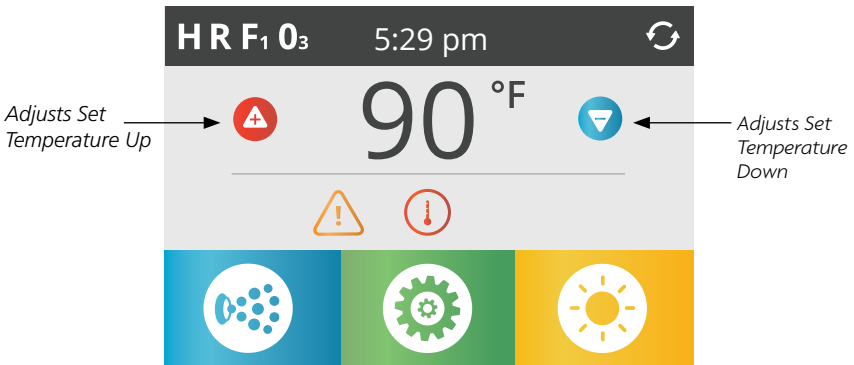

### SET TEMPERATURE

Press Up or Down once to display the Set Temperature (indicated by a flashing °F or °C). Press Up or Down again to modify the Set Temperature. The Set Temperature changes immediately.

If you need to switch between High Temperature Range and Low Temperature Range you need to go to the Settings Screen.

### PRESS-AND-HOLD

If Up or Down is pressed and held, the temperature will continue to change until you stop pressing, or until the Temperature Range limits are reached.

### LIGHTS

The Lights Icon  turns the lights (if equipped) inside your swim spa on or off. If your swim spa is equipped with LED Light System, turn the lights on and off repeatedly within a couple of seconds to rotate through available color schemes.

# SWIM SPA CONTROLS - ICON SPA TOUCH

## THE SPA SCREEN

### ALL EQUIPMENT ACCESS

The Swim Spa Equipment Icon  takes you to the Spa Screen, which shows all available equipment\* to control. The display shows icons that are related to the equipment installed on a particular swim spa model, so this screen may change depending on the installation.

The icon buttons are used to select and control individual devices.

Some devices, like pumps, may have more than one ON state, so the icon will change to reflect the state of the equipment. Below are some examples of 2-speed Pump indicators.



*Jets Off*



*Jets Low*



*Jets High*

If the swim spa has a Circulation Pump, a Circulation Pump Icon will appear to indicate its activity, but outside of Priming Mode, the Circulation Pump cannot be controlled directly.



*Circulation Pump*  
If equipped, it is only controllable in Priming Mode during initial power-up.

*\*One exception: The Main Spa Light is not shown on the Spa Screen; it is only shown (and controlled) on the Main Screen.*

# SWIM SPA CONTROLS - ICON SPA TOUCH

## COMMON BUTTONS

### VALUES INCREMENT/DECREMENT

If an Up or Down button is shown and pressed when on an editing page, and a value has been selected (highlighted), the value can be increased by pressing the Up Arrow or decreased by pressing the Down Arrow.

### INVERT

Will appear on upper right on all screens.

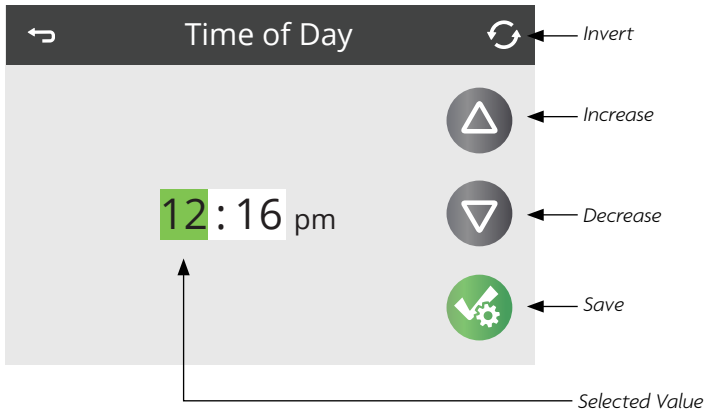

# SWIM SPA CONTROLS - ICON SPA TOUCH

## COMMON BUTTONS

### EXITING SCREENS

The Back button is on every screen except the Main Screen, the Priming Mode Screen and Message Display Screen.

When you see only this button, or this button plus an Inactive Save Button, it means Back or Exit. It appears on editing screens before you have changed any value, as well as on all other screens.

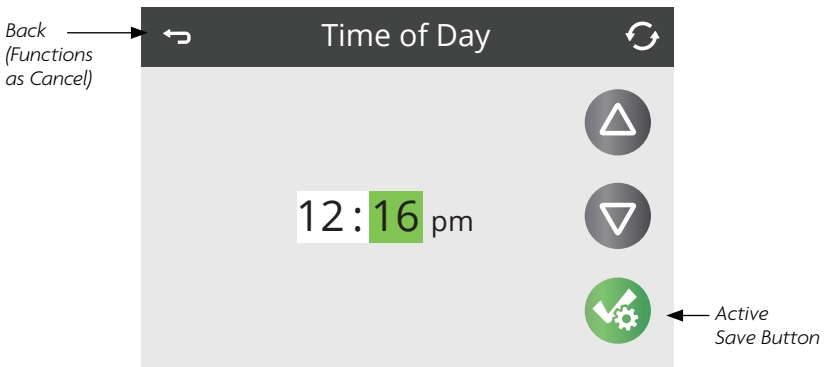
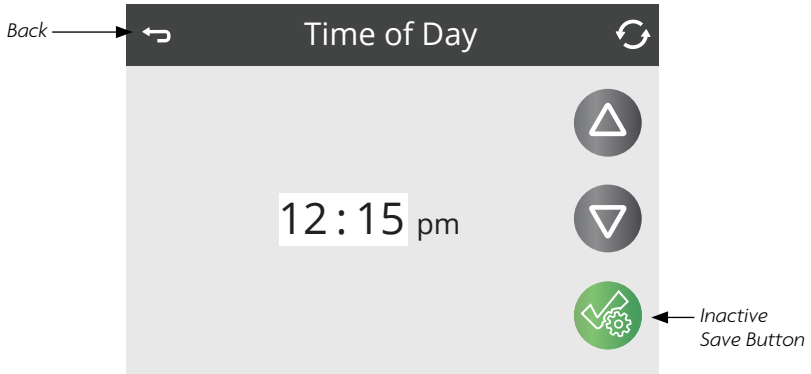

When you see both the Back button and an Active Save button, the Save button will Save, turning the green selection to white, while the Back button will Cancel. If the screen times out due to no activity it will act like Cancel.

# SWIM SPA CONTROLS - ICON SPA TOUCH

## COMMON BUTTONS

### PAGE RIGHT/LEFT

If there is a Right Arrow at the bottom of the screen, it takes you to the next page.

If there is a Left Arrow at the bottom of the screen, it takes you to the previous page.

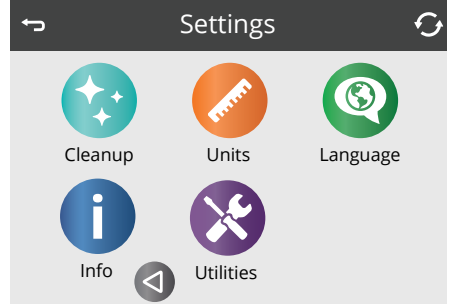

### PAGE UP/DOWN

If an Up or Down button is shown and pressed when on a page with a text list, the list can be scrolled a page at a time.

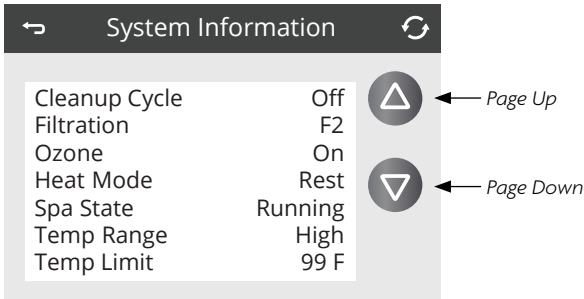

# SWIM SPA CONTROLS - ICON SPA TOUCH

## THE SETTINGS SCREEN

### PROGRAMMING, ETC.

The Settings Icon  takes you to the Settings Screen, where all programming and other swim spa behaviors are controlled.

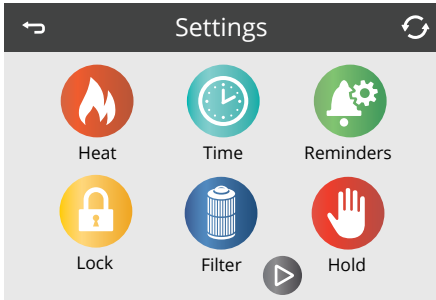

Each icon on the Settings screen takes you to a different screen, where one or more settings may be viewed and/or edited.

### HEAT MENU

The Heat Icon  in the Settings Screen takes you to a screen where you can control the Heat Mode and the Temperature Range.

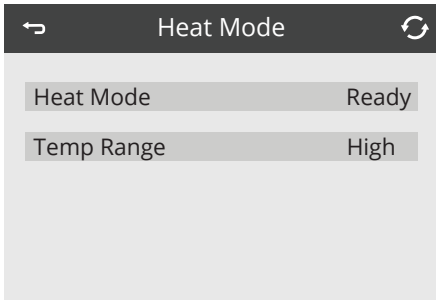

### TEMPERATURE RANGES (HIGH VS. LOW)

This system incorporates two temperature range settings with independent set temperatures. The specific range can be selected on the Settings Screen and is visible on the Main Screen in the upper left corner of the display. These ranges can be used for various reasons, with a common use being a “ready to use” setting vs. a “vacation” setting. Each range maintains its own set temperature as programmed by the user. This way, when a range is chosen, the swim spa will heat to the set temperature associated with that range. Check the set water temperature and consider lowering it for the times when the swim spa will typically not be in use.

The swimming/exercising water temp, while in High Temp Range, can be set between 80°F (27°C) and 99°F (37°C). For Trainer 19 and Momentum models, the separate hot tub body of water High Temp Range can be set between 80°F (27°C) and 104°F (40°C). Low Range can be set between 50°F (10°C) and 99°F (37°C). Freeze Protection is active in either range. Consider that the comfortable temperature range during use may be lower than the maximum safe temperature.



# SWIM SPA CONTROLS - ICON SPA TOUCH

## THE SETTINGS SCREEN

### HEAT MODE – READY VS. REST

In order for the swim spa to heat, a pump needs to circulate water through the heater. The pump that performs this function is known as the “heater pump”. The heater pump can be either a 2-speed Pump (Pump 1) or a Circulation Pump.

#### READY MODE

If the heater pump is a 2-speed Pump 1, Ready Mode will circulate water periodically, using Pump 1 Low, in order to maintain a constant water temperature, heat as needed, and refresh the temperature display. This is known as “polling”.

#### REST MODE

If the swim spa is not going to be used for a prolonged period of time, this mode will only allow heating during programmed filter cycles. Since polling does not occur, the temperature display may not show a current temperature until the heater pump has been running for a minute or two. This is seen on the screen as: **\_\_ \_\_ \_\_ °F** **\_\_ \_\_ \_\_ °C**. Using Rest Mode is not recommended in below freezing temperatures.

#### READY-IN-REST MODE

Ready in Rest Mode appears in the display if the swim spa is in Rest Mode and the Jets 1 Button is pressed. When the heater pump has come on automatically (for example for heating) you can switch between low speed and high speed but you cannot turn the heater pump off. After 1 hour, the System will revert to Rest Mode. This mode can also be reset by selecting the Heat Mode.

### M8 SMART TEMPERATURE MONITORING

As a default, the M8 Icon  is set as ON/Active. M8 affects the swim spa operation behavior for non-circulation pump systems which use therapy Pump 1 (Jets 1) low speed for monitoring swim spa water temperature, heating and filtering. If your swim spa has a dedicated circulation pump system such as Quietflo or Mast3rPur, these behaviors do not apply.



ON/Active



OFF/Inactive

While ON/Active and the swim spa system set to Ready Heat Mode, M8 can actively change Pump 1 low speed water temperature polling intervals from every 30 minutes to become less frequent, up to 2 hours in between polling points, if the swim spa water temperature is remaining very stable.

The screen will show: **\_\_ \_\_ \_\_ °F** **\_\_ \_\_ \_\_ °C** any time the polling interval extends beyond 30 minutes. This indicates the spa does not know what the exact water temperature is. To see the current water temperature, activate Pump 1, so the system can check the temperature.

If set to OFF/Inactive and the swim spa system set to Ready Heat Mode, the spa control system will only poll to check current swim spa water temperature every 30 minutes.

# SWIM SPA CONTROLS - ICON SPA TOUCH

## FILL IT UP!

### PREPARATION AND FILLING

Fill the swim spa to its correct operating level, using the instructions found in Initial Swim Spa Setup under the Installation Instructions section.

#### PRIMING MODE – M019\*

After the initial start-up sequence, the control will enter Priming Mode and display a Priming Mode screen. Only pump icons appear on the priming mode screen. During the priming mode, the heater is disabled to allow the priming process to be completed without the possibility of energizing the heater under low-flow or no-flow conditions. Nothing comes on automatically, but the pump(s) can be energized by selecting the “Jet” buttons. If the swim spa has a Circulation Pump, it can be turned on and off by pressing the “Circ” button during Priming Mode.

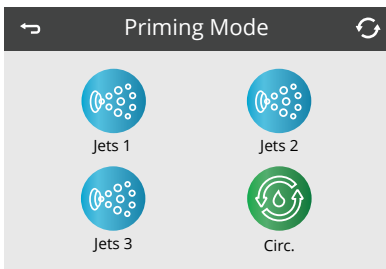

#### PRIMING THE PUMPS

As soon as the Priming Mode screen appears on the panel, select the “Jets 1” button once to start Pump 1 in low-speed (if applicable) and then again to switch to high-speed. If the pump is operating but there is no water flow after 10 seconds of running, shut the pump off for 5-10 seconds and then back on for 5-10 seconds. Repeat until water begins flowing, this means the pump is primed. Also select the other pumps to turn them on and perform this priming process if necessary. If the pumps have not primed

after 4-5 minutes, and water is not flowing from the jets in the swim spa, do not allow the pumps to continue to run. Turn the swim spa off, then back on and repeat the process.

**NOTE:** Turning the power off and back on again will initiate a new pump priming session. Do not do this more than 5 times. If the pump(s) will not prime, shut off the power to the swim spa and see instructions for relieving an air lock in the Initial Swim Spa Setup section.

**IMPORTANT:** A pump should not be allowed to run continuously without priming for more than 2 minutes. Under NO circumstances should a pump be allowed to run without priming beyond the end of the 4-5 minute priming mode. Doing so may cause damage to the pump and cause the system to energize the heater and go into an overheat condition.

#### EXITING PRIMING MODE

The system will automatically enter the normal heating and filtering at the end of the priming mode, which lasts 4-5 minutes. You can manually exit Priming Mode by pressing the “Back” button on the Priming Mode Screen. Note that if you do not manually exit the priming mode as described above, the priming mode will be automatically terminated after 4-5 minutes. Be sure that the pump(s) have been primed by this time. Once the system has exited Priming Mode, the top-side panel will display the Main Screen, but the display will not show the water temperature yet, as shown below. This is because the system requires approximately 1 minute of water flowing through the heater to determine the water temperature and display it. The panel will display the following until it is able to get a temperature read:             °F             °C

\*M0XX is a Message Code. See Messages Log in the Utilities section.

# SWIM SPA CONTROLS - ICON SPA TOUCH

---

## SWIM SPA BEHAVIOR

### PUMPS

On the Spa Screen, select a “Jets” button once to turn the pump on or off, and to shift between low- and high-speeds if equipped. If left running, the pump will turn off after a time-out period (15 minutes at high speed).

### NON-CIRCULATION SYSTEMS

To monitor current water temperature, the system will automatically activate Pump 1 at the low-speed setting as needed. If the swim spa is in Ready Mode, Pump 1 low may activate for at least 1 minute every 30 minutes to monitor the swim spa water temperature (known as polling) and begin to heat if water temperature has dropped below the set temperature. If the water temperature remains consistent over long periods, and does not decrease, the M8 technology in your swim spa will actively adapt these polling intervals to be less frequent. If the water temperature conditions are very stable, M8 will gradually increase time between the intervals, up to 2 hours. If the water temperature starts dropping significantly, the system will check the water temperature (poll) more frequently, reverting the interval back to every 30 minutes. It will also reset the intervals back to 30 minutes whenever the user interacts with the system (such as activating equipment, changing heating modes and modifying the set temperature).

Pump 1 runs automatically, at the low-speed setting, when any other pump is turned on (if equipped) so that the system can monitor the swim spa water temperature.

When the low-speed of Pump 1 turns on automatically for either temperature polling, heating or filter cycles, it cannot be turned off at the control panel. However, the high speed setting on the pump can be turned on.

### CIRCULATION PUMP MODES

If the system is equipped with a circulation pump, it will be configured to work in one of two different ways depending on the control system software. The circulation pump mode cannot be changed.

1. Most circulation pumps operate continuously (24 hours) with the exception of turning off for 30 minutes at a time when the water temperature reaches 3°F (1.5°C) above the set temperature (most likely to happen in warm climates or if set temperature is lowered/set below the current water temperature). This is the typical mode for most swim spas with a dedicated circulation pump.
2. A programmable circulation pump will come on when the system is checking temperature (polling), during filter cycles, during freeze conditions, or when another pump is on.

### FILTRATION AND OZONE

On non-circulation systems, Pump 1 low and the ozone generator will run during filtration. On circulation systems, the ozone will generally run with the circulation pump.

The system is factory-programmed with one filter cycle that will run in the evening (assuming the time-of-day is properly set) when energy rates are often lower. The filter time and duration are programmable. A second filter cycle can be enabled as needed.

At the start of each filter cycle, the pumps will run briefly to purge the plumbing to maintain good water quality.

See Adjusting Filtration section within Swim Spa Controls for more information.

# SWIM SPA CONTROLS - ICON SPA TOUCH

---

## SWIM SPA BEHAVIOR

### **FREEZE PROTECTION**

If the temperature sensors within the heater detect a low enough temperature, then the pumps automatically activate to provide freeze protection. The pumps will run either continuously or periodically depending on conditions.

### **CLEAN-UP CYCLE (OPTIONAL)**

When a pump is turned on by a button press, a clean-up cycle begins 30 minutes after the pump is turned off or times out. The heat/filter pump and the ozone generator will run for 30 minutes or more, depending on the system. If the swim spa has a 24hr circulation pump which performs as the heat and filter pump, the cleanup cycle will not apply as the 24hr circulation pump provides constant filtration. On some systems, you can change this setting. See the Cleanup Cycle section in Additional Settings.

# SWIM SPA CONTROLS - ICON SPA TOUCH

## TIME-OF-DAY

### SETTING THE TIME-OF-DAY

Be sure to set the time-of-day, it is important for determining filtration times and other background features.

The Time Icon  on the Settings Screen takes you to a screen where you control the Time-of-Day. On the Time-of-Day screen, use the Up and Down Buttons to make changes to the highlighted green field. You can toggle between hours and minutes to make changes by touching the numbers on the screen. When finished, Save and the green field will turn white.

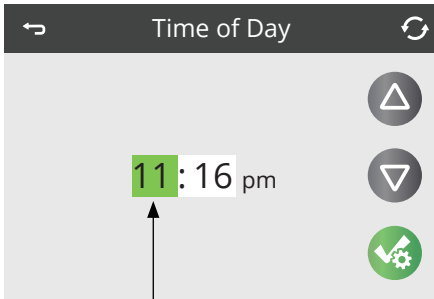

*Green highlight shows an active field to edit*

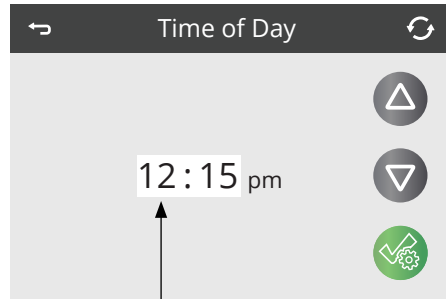

*Field changes to white when saved*

If no time-of-day is set in the memory an Information Screen will appear. If you exit it an Information Icon will appear at the bottom of the Main Screen, until the time-of-day has been set.

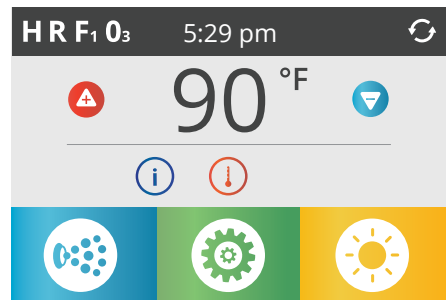
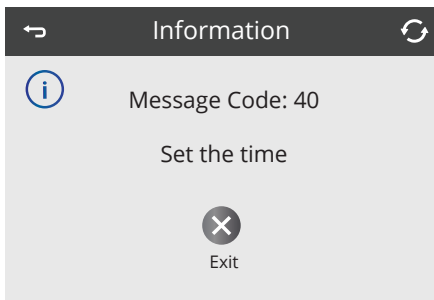

# SWIM SPA CONTROLS - ICON SPA TOUCH

## ADJUSTING FILTRATION

### MAIN FILTRATION

Using similar adjustments as the Time-of-Day Screen on previous page, Filter Cycles are set using a start time and an end time. Each setting can be adjusted in 15-minute increments. The panel calculates the duration and displays it automatically.

The Filter Icon  on the Settings Screen takes you to a screen where you control the Filter Cycles.

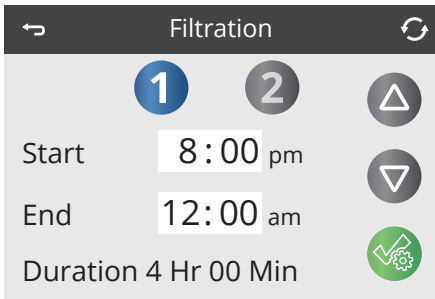

### FILTER CYCLE 2 - OPTIONAL FILTRATION

Filter Cycle 2 is OFF by default on most systems. Press "1" to view Filter 1. Press "2" once to view Filter 2. Press "2" again to turn Filter 2 ON or OFF.

When Filter Cycle 2 is ON, it can be adjusted in the same manner as Filter Cycle 1.

It is possible to overlap Filter Cycle 1 and Filter Cycle 2, which will shorten overall filtration by the overlap amount.

#### Viewing Filter 1 while Filter 2 is OFF:

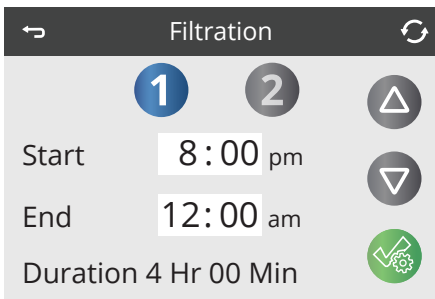

#### Viewing Filter 2 when it is ON and selected:

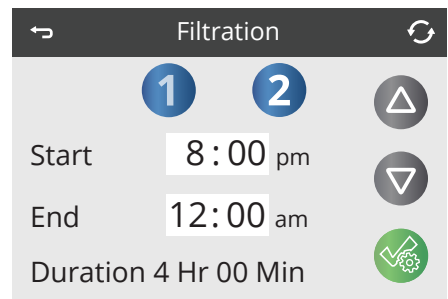

# SWIM SPA CONTROLS - ICON SPA TOUCH

---

## ADJUSTING FILTRATION

### PURGE CYCLES

In order to maintain sanitary conditions, as well as protect against freezing, all pumps will purge water from their respective plumbing by running briefly at the beginning of each filter cycle. It is best that all jets be left in their open position and water diverters in their centered positions when done using the swim spa so all jets get water flow during purge cycles.

If the Filter Cycle 1 duration is set for 24 hours, enabling Filter Cycle 2 will initiate a purge when Filter Cycle 2 is programmed to begin.

### THE MEANING OF FILTER CYCLES

1. The heating pump always runs during the filter cycle\*
2. In Rest Mode, heating only occurs during the filter cycle
3. Purges happen at the start of each filter cycle

\* For example, if your swim spa is set up for 24/hour circulation except for shutting off when the water temperature is 3°F/1.3°C above the set temperature, that shutoff does not occur during filter cycles.

# SWIM SPA CONTROLS - ICON SPA TOUCH

## RESTRICTING OPERATION

The control can be restricted to prevent unwanted use or temperature adjustments.

Locking the Panel prevents the control panel from being used, but all automatic functions are still active.

Locking the Settings allows Jets and other features to be used, but the Set Temperature and other programmed settings cannot be adjusted. Settings Lock allows access to a reduced selection of menu items. These include Filter Cycles, Invert, Information and Messages. They can be seen, but not changed or edited.

### Settings Unlocked and Panel Unlocked

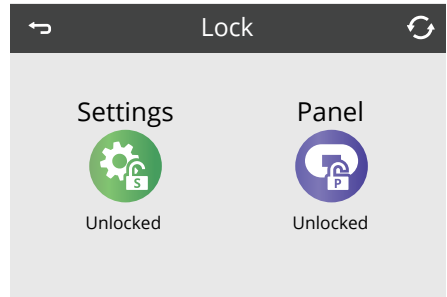
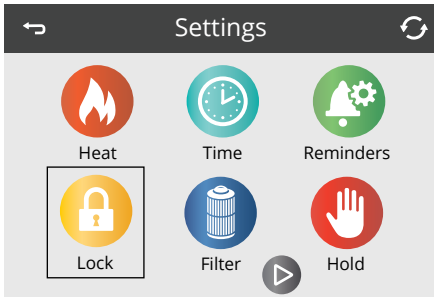

## LOCKING AND UNLOCKING

### Settings Unlocked and Panel Locked

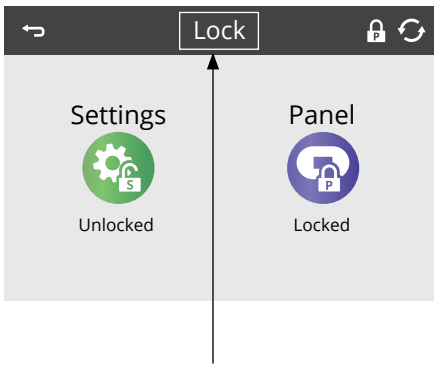

After you have touched the Settings or Panel Icon, press here for 5 seconds to lock or unlock.

The same steps are used to Lock and Unlock Panel or Settings.

#### TO LOCK:

1. Select Settings Icon (if it says "Unlocked") or Panel Icon (if it says "Unlocked")
2. Press and hold the word "Lock" in the title bar for at least 5 seconds

#### TO UNLOCK:

1. Select Settings Icon (if it says "Locked") or Panel Icon (if it says "Locked")
2. Press and hold the word "Lock" in the title bar for at least 5 seconds

 with 'S' = Settings Lock

 with 'P' = Panel Lock



# SWIM SPA CONTROLS - ICON SPA TOUCH

---

## ADDITIONAL SETTINGS

### HOLD - M037\*

The Hold Icon  on the Settings Screen places the swim spa in Hold Mode and displays the System Hold screen.

Hold Mode is used to disable the swim spa equipment during service functions like cleaning or replacing the filter. Hold Mode will last for 1 hour unless the mode is exited manually. If swim spa service will require more than an hour, it may be best to simply shut down power to the swim spa.

Touch Back to exit Hold Mode.

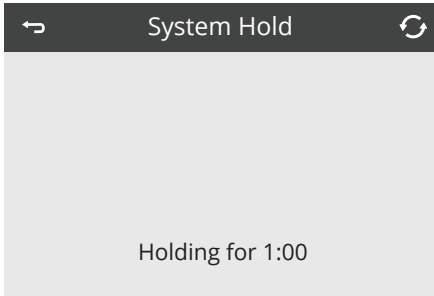

*\*M0XX is a Message Code. Codes like this will be seen in the Messages Log.*

# SWIM SPA CONTROLS - ICON SPA TOUCH

## THE UTILITIES SCREEN

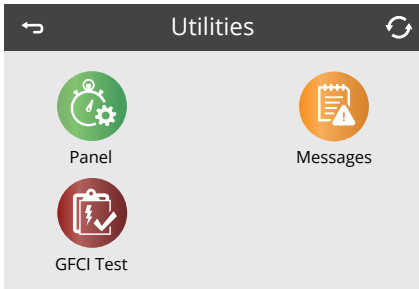

### UTILITIES

The Utilities Icon  in the Settings Screen takes you to the Utilities Screen. The Utilities Screen may contain the following:

#### PANEL

Allows you to set the time that the screen goes to sleep after so many minutes of inactivity. For example, you can set your control panel screen to shut off 10 minutes after you've last touched the screen.

### MESSAGES LOG

The Messages Log is a record of the last 24 errors or messages that can be reviewed by a service tech. Use the Up and Down buttons to view each of the messages. When Priming Mode shows in the Messages Log, it is not an error. Rather, it is used to keep track of swim spa restarts.

#### **GFCI TEST** (Feature not available on all systems)

GFCI Test will not appear on the screen if the feature is not available. This screen allows the GFCI to be tested manually from the swim spa control panel (See more in Utilities - GFCI Test Feature).

# SWIM SPA CONTROLS - ICON SPA TOUCH

## ADDITIONAL SETTINGS

### UNITS

The Units Icon  on the Settings Screen takes you to the Units Screen.

Press “Temp Display” to change the temperature between Fahrenheit and Celsius.

Press “Time Display” to change the clock between 12 HR and 24 HR display.

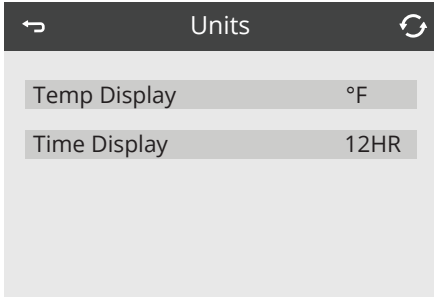

### REMINDERS

The Reminder Icon  on the Settings Screen takes you to the Reminders Screen.

Reminders are preprogrammed routine maintenance reminders that appear on the Main Screen as  at different intervals and will help guide you in taking care of your swim spa.

Press “Reminders” to turn them ON (which displays as Yes) or OFF (Displays as No). This will allow reminders like "Clean Filters" to appear. To see a full listing of Reminder Messages, refer to "Reminder Messages" in the back of the Swim Spa Controls section.

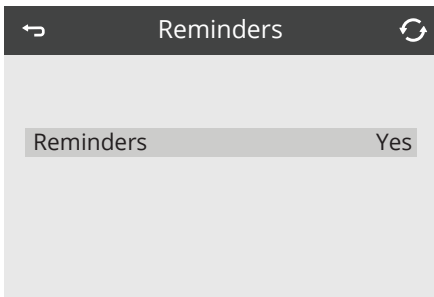

# SWIM SPA CONTROLS - ICON SPA TOUCH

## ADDITIONAL SETTINGS

### CLEANUP CYCLE

Cleanup Cycle Duration is not always enabled, so it may not appear. When it is available, set the length of time the heat/filter pump will run after each use. 0-4 hours are available. Setting to 0.0 Hr prevents the Cleanup Cycles from running.

The Cleanup Icon  on the Settings Screen takes you to the Cleanup Cycle screen.

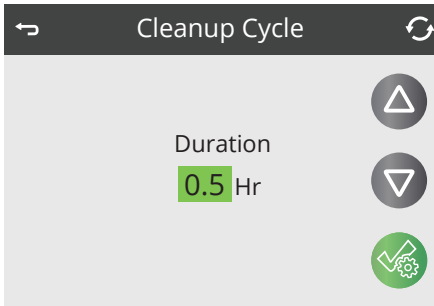

**NOTE:** Cleanup cycles do not apply to systems set for 24hr circulation pump mode as the circulation pump performs as the heat and filter pump to provide constant filtration.

### LANGUAGE

The Language Icon  on the Settings Screen takes you to the Language Screen.

Change the language displayed on the panel by pressing the arrow keys. The light grey highlight indicates the language you are changing it to.

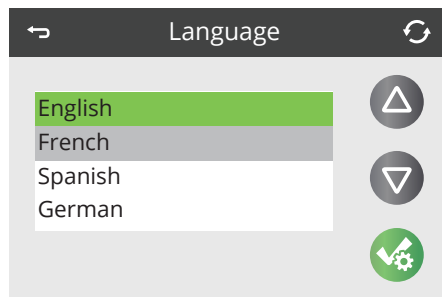
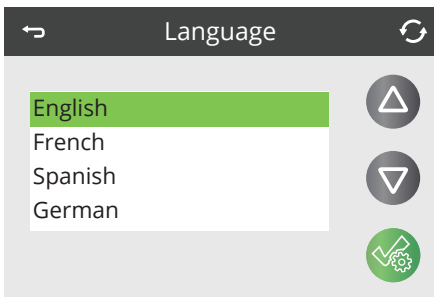

# SWIM SPA CONTROLS - ICON SPA TOUCH

## INFORMATION

### SYSTEM INFORMATION

The Information Icon  on the Settings Screen takes you to the System Information screen, which displays various settings and system identification.

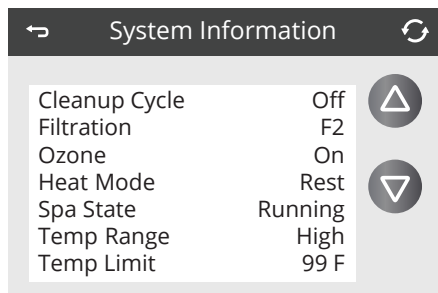

### SYSTEM MODEL

Displays the Model Number of the System.

### PANEL VERSION

Displays a number of the software in the topside control panel.

### SOFTWARE ID (SSID)

Displays the software ID number for the System.

### CONFIGURATION SIGNATURE

Displays the checksum for the system configuration file.

### CURRENT SETUP

Displays the currently selected Configuration Setup Number.

### DIP SWITCH SETTINGS

Displays a number that represents the DIP switch positions of S1 on the main circuit board.

### HEATER VOLTAGE (Feature not used on CE rated systems)

Displays the operating voltage configured for the heater.

### HEATER WATTAGE AS CONFIGURED IN SOFTWARE (CE Systems Only)

Displays a heater kilowatt rating as programmed into the control system software (1-3 or 3-6).

### HEATER TYPE

Displays a heater type ID number.

# SWIM SPA CONTROLS - ICON SPA TOUCH

## UTILITIES – GFCI TEST FEATURE

The Ground Fault Circuit Interrupter (GFCI) or Residual Current Detector (RCD) is an important safety device and is required equipment on a swim spa installation.



### **FORCING THE GFCI TRIP TEST** (North America Only)

Touching the GFCI Test Icon on the Utilities Screen takes you to the GFCI Test screen. This feature is not available on all systems. The GFCI Test icon will only display if the system is capable of this feature. Some UL registered systems do not have the GFCI Test Feature.

The installer can use the GFCI Trip Test to confirm proper function of the GFCI.

The GFCI should trip within several seconds and the swim spa should shut down. If it does not, shut down the power and manually verify that a GFCI breaker is installed and that the circuit and swim spa are wired correctly. Verify the function of the GFCI with its own test button. Restore power to the swim spa and repeat the GFCI Trip Test.

Once the GFCI is tripped by the test (causing the swim spa to be shut off from power being removed), reset the GFCI breaker to turn swim spa back on. You can verify a successful test by navigating to the above screen. "Passed" should appear after the Reset line is selected on the GFCI screen.

### **CE PRODUCT**

CE registered systems do not have an RCD Test Feature due to the nature of the electrical service. The end-user must be trained how to properly test and reset the RCD.

# SWIM SPA CONTROLS - ICON SPA TOUCH

## GENERAL MESSAGES

### MESSAGES

Most messages and alerts will appear at the bottom of the Main Screen. Several alerts and messages may be displayed in a sequence.

### WATER TEMPERATURE IS UNKNOWN

After the pump has been running for 1 minute, the temperature will be displayed.

— — — — °F      — — — — °C



### POSSIBLE FREEZING CONDITION

A potential freeze condition has been detected, or the Aux Freeze Switch has closed. All water devices are activated. In some cases, pumps may turn on and off and the heater may operate during Freeze Protection. This is an operational message, not an error indication.

### THE WATER IS TOO HOT – M029\*

The system has detected a swim spa water temp of 110°F (43.3°C) or more, and swim spa functions are disabled. System will auto reset when the swim spa water temp is below 108°F (42.2°C). Check for extended pump operation (i.e. filter cycle durations or extended swim spa pump use beyond the 15 minute timeouts) and warm ambient temperatures.

*\*M0XX is a Message Code. Codes like this will be seen in the Messages Log.*

# SWIM SPA CONTROLS - ICON SPA TOUCH

## HEATER-RELATED MESSAGES

### THE WATER FLOW IS LOW – M016\*\*

There may not be enough water flow through the heater to carry the heat away from the heating element. Heater start up will begin again after about 1 min. See “Flow Related Checks” below.

### THE WATER FLOW HAS FAILED\* – M017\*\*

Several Heater Flow Losses have occurred within 24 hours indicating confirmed low flow or complete flow loss. There is not enough water flow being constantly maintained through the heater to carry the heat away from the heating element and the heater has been disabled. See “Flow Related Checks” below. After the problem has been resolved, reset the message\*.

### THE HEATER MAY BE DRY\* – M028\*\*

Possible dry heater, not enough water in or flowing to the heater to start it. The swim spa is shut down for 15 minutes but will retry (up to 3 times). Reset this message\* to reset the heater start-up. See “Flow Related Checks” below.

### THE HEATER IS DRY\* – M027\*\*

Consecutive Heater May Be Dry errors have occurred and there is a verified problem. There is a flow restriction, no flow or air lock in system preventing proper water flow for heater operation. The swim spa is shut down. After the problem has been resolved, you must reset the message\* to reset and restart heater. See “Flow Related Checks” below.



### THE HEATER IS TOO HOT\* – M030\*\*

One of the water temp sensors has detected 118°F (47.8°C) in the heater and the swim spa is shut down. You must reset the message\* when water is below 108°F (42.2°C). See “Flow Related Checks” below.

## FLOW-RELATED CHECKS

Check filters for possible blockage. Try cleaning or replacing filters (especially if swim spa is equipped with 24 hour circulation pump).

Check for low water level, suction flow restrictions (i.e. any leaves or debris pulled against suction fittings in bottom of swim spa shell), closed valves, too many closed jets and pump prime/air locked pump (see initial swim spa setup for instruction on relieving pump air lock).

On some systems, even when swim spa is shut down by an error condition, some equipment may occasionally turn on to continue monitoring the temperature or if freeze protection is needed.

\* Some messages can be reset from the panel. Messages that can be reset will appear with a Clear Icon at the bottom of the Message Screen. Press the Clear Icon to reset the system.

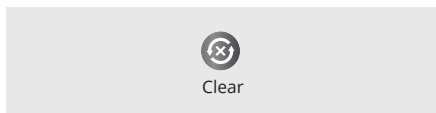

\*\*M0XX is a Message Code. Codes like this will be seen in the Messages Log.



# SWIM SPA CONTROLS - ICON SPA TOUCH

---

## SENSOR-RELATED MESSAGES

### SENSORS ARE OUT OF SYNC – M015\*\*

The temperature sensors MAY be out of sync by 3°F (1°C). Contact your Master Spas dealer or service organization if this message does not disappear within a few minutes.

### SENSORS ARE OUT OF SYNC – CALL FOR SERVICE\* – M026\*\*

The temperature sensors ARE out of sync. The fault above has been established for at least 1 hour. Contact your Master Spas dealer or service organization.

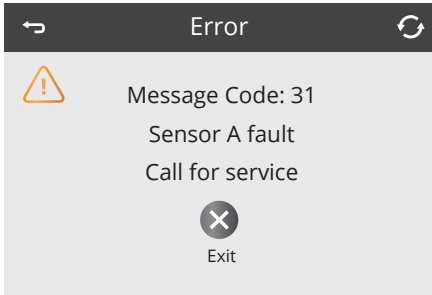

### SENSOR A FAULT, SENSOR B FAULT –

### SENSOR A: M031\*\*, SENSOR B: M032\*\*

A temperature sensor or sensor circuit has failed. Contact your Master Spas dealer or service organization.

---

## MISCELLANEOUS MESSAGES

### COMMUNICATIONS ERROR

The control panel is not receiving communication from the System. Contact your Master Spas dealer or service organization.

### TEST SOFTWARE INSTALLED

The Control System is operating with test software. Contact your Master Spas dealer or service organization.

\* Some messages can be reset from the panel. Messages that can be reset will appear with a Clear Icon at the bottom of the Message Screen. Press the Clear Icon to reset the message.

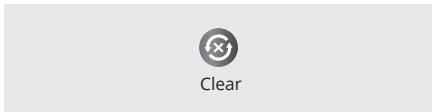

\*\*M0XX is a Message Code. Codes like this will be seen in the Messages Log.

# SWIM SPA CONTROLS - ICON SPA TOUCH

---

## SYSTEM-RELATED MESSAGES

### **PROGRAM MEMORY FAILURE\* – M022\*\***

At power-up, the system has failed the Program Checksum Test. This indicates a problem with the firmware (operation program). Contact your Master Spas dealer or service organization.

### **THE SETTINGS HAVE BEEN RESET (PERSISTENT MEMORY ERROR)\* – M021\*\***

Contact your Master Spas dealer or service organization if this message appears on more than one power-up.

### **THE CLOCK HAS FAILED\* – M020\*\***

Contact your Master Spas dealer or service organization.

### **CONFIGURATION ERROR (SWIM SPA WILL NOT START UP)**

Contact your Master Spas dealer or service organization.

### **THE GFCI TEST FAILED (SYSTEM COULD NOT TEST THE GFCI) – M036\*\***

(North America Only) May indicate an unsafe installation. Contact your Master Spas dealer or service organization as well as your electrician. A GFCI replacement will require an electrician.

### **A PUMP MAY BE STUCK ON – M034\*\***

Water may be overheated. POWER DOWN THE Swim spa. DO NOT ENTER THE WATER. Contact your Master Spas dealer or service organization.

### **HOT FAULT – M035\*\***

A Pump Appears to have been Stuck ON when swim spa was last powered POWER DOWN THE Swim spa. DO NOT ENTER THE WATER. Contact your Master Spas dealer or service organization.

\* Some messages can be reset from the panel. Messages that can be reset will appear with a Clear Icon at the bottom of the Message Screen. Press the Clear Icon to reset the message.



Clear

\*\*M0XX is a Message Code. Codes like this will be seen in the Messages Log.

# SWIM SPA CONTROLS - ICON SPA TOUCH

---

## REMINDER MESSAGES

### REMINDER MESSAGES OF ROUTINE MAINTENANCE

Reminder Messages can be turned off by using the Reminders Screen.

Reminders are preprogrammed routine maintenance reminders that appear on the Main Screen as  at different intervals and will help guide you in taking care of your swim spa. Some messages may not apply depending on the actual equipment in the swim spa.

#### CHECK THE PH

May appear on a regular schedule, i.e. every 7 days. Check pH with a test kit and adjust pH with the appropriate chemicals.

#### CHECK THE SANITIZER

May appear on a regular schedule, i.e. every 7 days. Check sanitizer level and other water chemistry with a test kit and adjust with the appropriate chemicals.

#### CLEAN THE FILTER

May appear on a regular schedule, i.e. every 30 days.

#### TEST THE GFCI (OR RCD)

May appear on a regular schedule, i.e. every 30 days.

The GFCI or RCD is an important safety device and must be tested on a regular basis to verify its reliability.

Every user should be trained to safely test and reset the GFCI or RCD associated with the swim spa installation.

A GFCI or RCD will have a TEST button on it that allows a user to verify proper function.

#### CHANGE THE WATER

May appear on a regular schedule, i.e. every 180 days. Change the water in the swim spa on regular basis to maintain proper chemical balance and sanitary conditions.

Additional messages may appear on specific systems.

Reminder messages are simply cleared and automatically reset to appear at the next preprogrammed interval by clicking the Clear Icon.

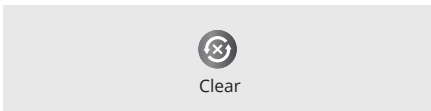

# SWIM SPA CONTROLS - ICON SPA TOUCH

---

## REMINDER MESSAGES

### **CLEAN THE COVER**

May appear on a regular schedule, i.e. every 30 days. Vinyl covers should be cleaned and conditioned for maximum life.

### **TREAT THE WOOD**

May appear on a regular schedule, i.e. every 180 days. Wood skirting and furniture should be cleaned and conditioned per the manufacturers instructions for maximum life.

### **CHANGE THE FILTER**

May appear on a regular schedule, i.e. every 365 days. Filters should be replaced periodically to maintain proper swim spa function and sanitary conditions. EcoPur® elements should be replaced every 180 days. Refer to Cleaning Your Filter Elements section in Routine Maintenance.

### **CHANGE THE UV**

May appear on a regular schedule, i.e. every 18 months. Change the UV as instructed in the Mast3rPur section. This is a general message and may not apply if swim spa is not equipped with UV.

### **CHECK OZONE**

May appear on a regular schedule, i.e. every 365 days. Check the ozone system as instructed in the Regular Maintenance Procedures.

Additional messages may appear on specific systems.

Reminder messages are simply cleared and automatically reset to appear at the next preprogrammed interval by clicking the Clear Icon.

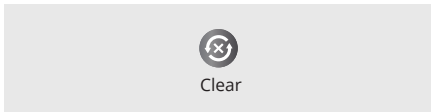

# SWIM SPA CONTROLS - PUMP CONTROL DIAGRAM

## INT MP FORCE D

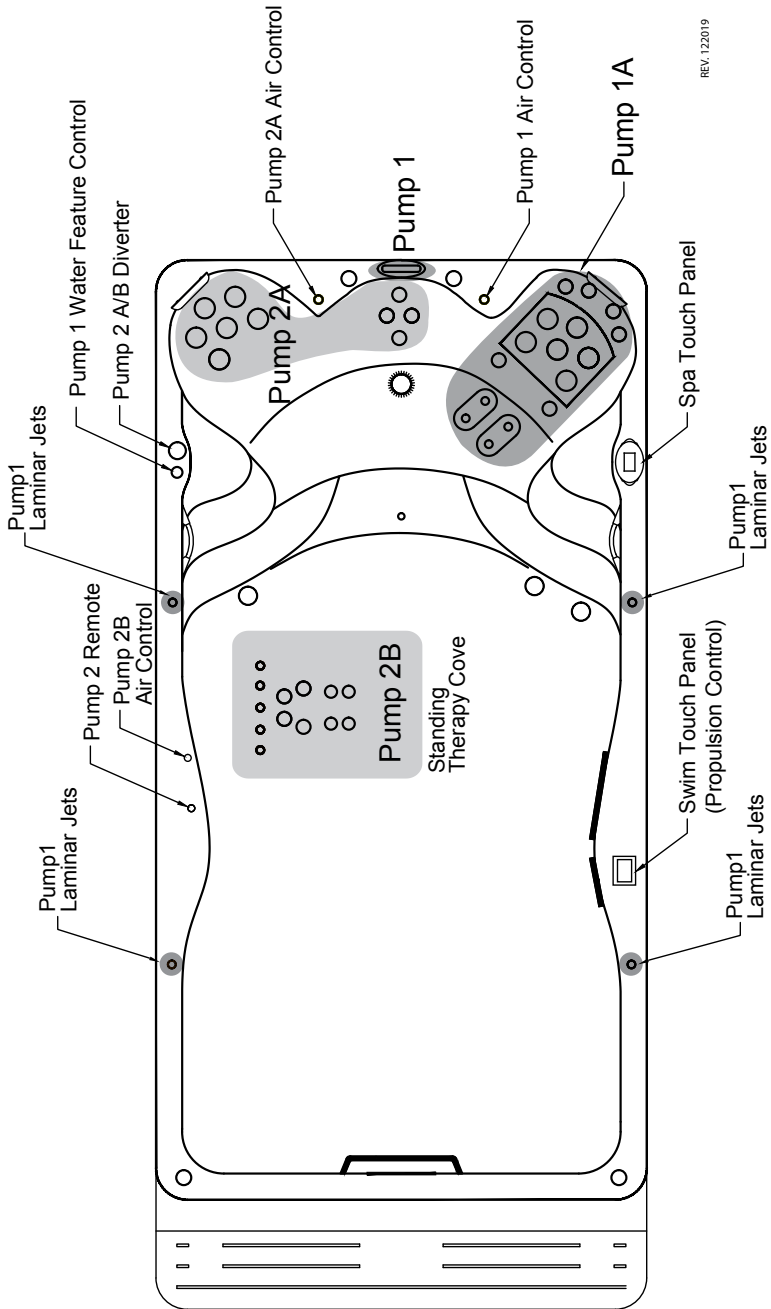



# SWIM SPA CONTROLS - PUMP CONTROL DIAGRAM

## INT MP MOMENTUM 80 D

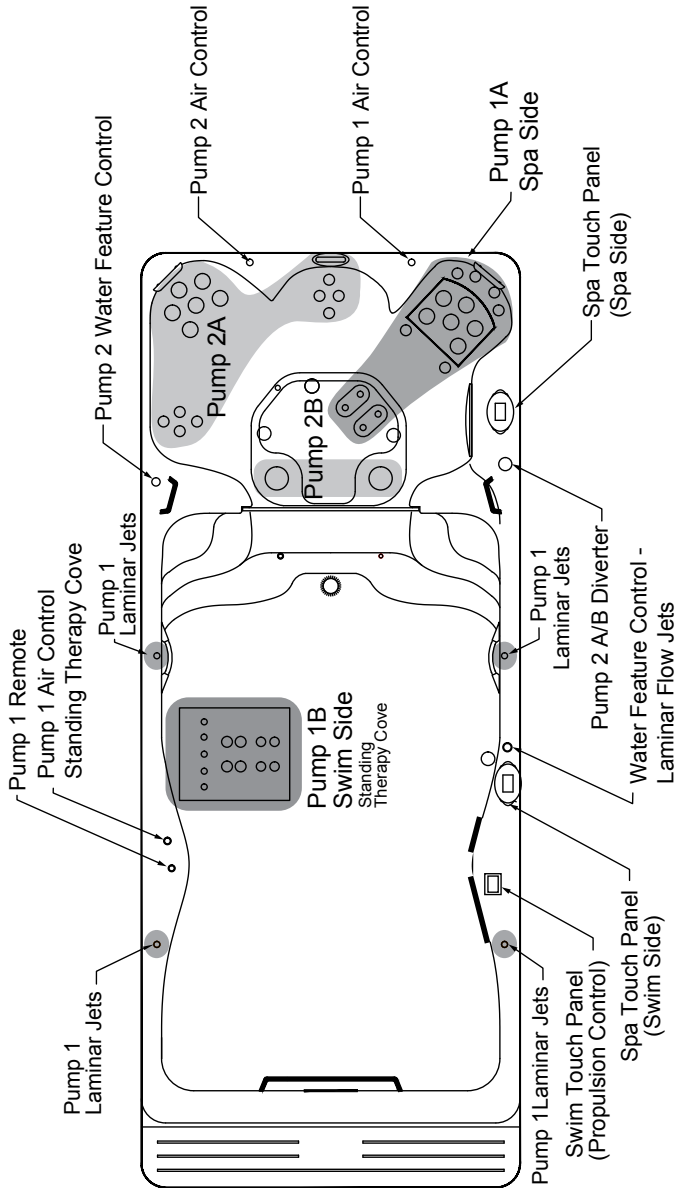

REV. 12/2019

# PROPULSION SYSTEM CONTROLS

---



## THE PROPULSION SYSTEM

The unique belt-driven propulsion system provides the most consistent flow of water to swim and exercise against. This propulsion system is controlled by the revolutionary Swim Number™ System.

The easy to operate propulsion control panel allows you not only to control the speed of the water flow but also to select from programmed Smart Workouts.



# PROPULSION SYSTEM CONTROLS

## SWIM CONTROL OPERATION

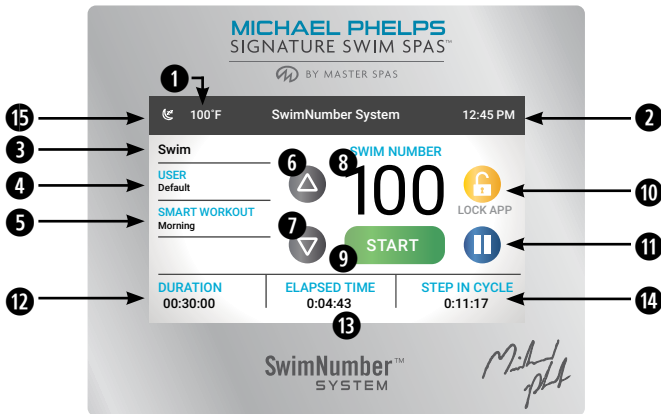

- ❶ **Temperature** of water in swim spa.
  - ❷ **Time** of day.
  - ❸ **Mode** indicates current workout type. You will not see a change in the swim current.
  - ❹ **User Default** User indication.
  - ❺ **Smart Workouts** can be selected by touching the highlighted area. Please refer to the Smart Workout Reference Guide included within this Propulsion System Controls section. From this menu you can select Smart Workouts that allow you to exercise using preprogrammed workouts that control the Wave Propulsion System.
  - ❻ **Up** button increases the swim number (speed).
  - ❼ **Down** button lowers the swim number (speed).
  - ❽ **Swim Number** indicates the speed of the propulsion system. Speed is indicated in numbers from 1 to 100, where the higher number indicates faster water flow.
  - ❾ **Start** button starts the propulsion system after a 5 second delay. This delay allows the swimmer time to get into position and prepare for the swim current.
  - ❿ **Lock APP** the use of this feature is no longer applicable.
  - ⓫ **Pause** button allows you to momentarily pause the operation of the propulsion system. Whenever it is restarted, there will be a 5 second delay before it resumes operation.
  - ⓬ **Duration** shows the duration of the complete workout.
  - ⓭ **Elapsed Time** will be displayed in a manual mode workout and indicates the total time that the propulsion system has been running in the current workout. It is only active in manual mode.  
**Remaining Time** will be displayed in a Smart Workout and indicates how much time is left to complete the workout.
  - ⓮ **Step in Cycle** indicates the time you have been in a specific workout step.
- NOTE:** If the topside control touch screen becomes erratic or will not function correctly, it may need to be synced to the main control pack. To sync the topside control hold the pause button until the display resets and shows "Synchronizing" in the lower left hand corner of the display.
- ⓯ **Instant Sleep** forces the screen to sleep immediately versus letting it time out after a few minutes. This can be used to help prevent splashing and water on the screen from causing undesired input on the touch panel.

**NOTE:** Water accumulating on the touch screen along with whether skin is dry or water soaked will result in misinterpreted inputs and/or reduced touch input capabilities. It is ideal to keep a dry towel nearby for best experience and use of touch panels.

# PROPULSION SYSTEM CONTROLS

## SMART WORKOUT REFERENCE GUIDE - FITNESS WORKOUTS

### BEGINNER FITNESS WORKOUT - 9 MIN. 30 SEC.

Step	Mode	Seconds	Wave XP Swim Number	Recommended Exercise*
1	Jog	15	1	Walking Forward
2	Jog	15	1	Walking Backward
3	Jog	15	1	Walking Sideways
4	Jog	15	1	Marching
5	Jog	15	1	Heel to Butt
6	Jog	15	1	Straight Leg Rise
7	Jog	15	1	Switch Legs
8	Jog	30	1	Trailing Forward/Back (Both Flow Directions)
9	Jog	45	1	Flies
10	Jog	45	1	Push/Pulls
11	Jog	45	1	Push Downs
12	Jog	45	1	Hip Flexion/Extension
13	Jog	45	1	Hip Abduction/Adduction
14	Jog	45	1	Core rotations. 2 hand start with isometric hold
15	Jog	45	1	Continue core rotations with Forward/Side Flow
16	Jog	120	12	Gentle jog into flow

### INTERMEDIATE FITNESS WORKOUT - 15 MIN. 15 SEC.

Step	Mode	Seconds	Wave XP Swim Number	Recommended Exercise*
1	Jog	25	1	Walking forward
2	Jog	25	1	Walking backward
3	Jog	25	1	Walking sideways (with both arms back)
4	Jog	25	1	Marching
5	Jog	25	1	Heel to butt with UE
6	Jog	25	1	Straight leg rise
7	Jog	25	1	Switch legs
8	Jog	25	1	Straight leg rise out
9	Jog	25	1	Switch legs
10	Jog	45	1	Flies forward
11	Jog	45	1	Switch legs
12	Jog	45	1	Flies side
13	Jog	45	1	Switch legs
14	Jog	45	1	Push/Pulls
15	Jog	45	1	Switch legs
16	Jog	45	1	Push downs
17	Jog	45	1	Switch legs
18	Jog	45	1	Power swings
19	Jog	45	1	Switch legs
20	Jog	45	1	Soccer kicks
21	Jog	45	1	Switch legs
22	Swim	30	56	Pikes in to flow
23	Jog	120	23	Running forward (no bells or fins)

\*For more exercise tips and workouts, consult the Aquatic Workout book provided in the box of the H2Xercise Kit.

# PROPULSION SYSTEM CONTROLS

## SMART WORKOUT REFERENCE GUIDE - FITNESS WORKOUTS

### ADVANCED FITNESS WORKOUT - 27 MIN.

Step	Mode	Seconds	Wave XP Swim Number	Recommended Exercise*
1	Jog	45	1	Walking forward
2	Jog	45	1	Walking forward
3	Jog	45	1	Walking sideways (one arm forward, one arm back)
4	Jog	45	1	Marching
5	Jog	45	1	Heel to butt with UE
6	Jog	45	1	Straight leg rise
7	Jog	45	1	Switch legs
8	Jog	45	1	Straight leg rise out
9	Jog	45	1	Switch legs
10	Jog	45	1	Straight leg rise in
11	Jog	45	1	Switch legs
12	Jog	75	1	Flies forward
13	Jog	75	1	Switch legs
14	Jog	75	1	Flies side
15	Jog	75	1	Switch legs
16	Jog	75	1	Alternating push/pulls
17	Jog	75	1	Switch legs
18	Jog	75	1	Alternating push downs
19	Jog	75	1	Switch legs
20	Jog	75	1	Power swings
21	Jog	75	1	Switch legs
22	Jog	75	1	Soccer kicks
23	Jog	75	1	Switch legs
24	Swim	45	1	Ronde De Jambe
25	Jog	60	45	Sprinting forward
26	Jog	60	45	Sprinting sideways
27	Jog	60	45	Sprinting backwards

\*For more exercise tips and workouts, consult the Aquatic Workout book provided in the box of the H2Xercise Kit.

# PROPULSION SYSTEM CONTROLS

## SMART WORKOUT REFERENCE GUIDE - TRAINING WORKOUTS

### BEGINNER TRAINING WORKOUT - 15 MIN.

Step	Mode	Seconds	Wave XP Swim Number	Recommended Exercise*
1	Swim	60	34	Breast stroke
2	Jog	60	34	Running in place
3	Jog	30	1	Step-up legs (30 sec. each leg)
4	Jog	60	45	Butt kicks
5	Jog	30	1	Arm circles forward/backward (30 sec. each direction)
6	Jog	60	45	High knees
7	Jog	60	1	Row bars
8	Jog	60	45	Running in place
9	Jog	30	1	Band - bicep curls (30 sec. each arm)
10	Jog	60	45	Butt kicks
11	Jog	60	1	Seated pull rows
12	Jog	60	45	High knees
13	Jog	30	1	Band (tricep extension)
14	Swim	60	45	Breast stroke
15	Swim	30	56	Body weight
16	Jog	60	23	Running in place

### INTERMEDIATE TRAINING WORKOUT - 30 MIN.

Step	Mode	Seconds	Wave XP Swim Number	Recommended Exercise*
1	Swim	120	34	Breast stroke
2	Jog	120	34	Running in place
3	Jog	60	1	Step-up legs (30 sec. each leg)
4	Jog	60	45	Butt kicks
5	Jog	60	1	Leg raise (60 sec. each leg)
6	Jog	60	1	Arm circles forward/backward (60 sec. each direction)
7	Jog	60	45	High knees
8	Jog	60	1	Band (shoulder press)
9	Swim	60	45	Breast stroke
10	Jog	60	1	Band (chest press)
11	Swim	60	34	Free style swim
12	Jog	60	1	Band - bicep curls (60 sec. each arm)
13	Swim	60	34	Free style swim
14	Jog	60	1	Seated pull rows
15	Jog	60	45	Running in place
16	Jog	60	1	Dumb bells push/pull
17	Jog	60	45	Breast stroke
18	Jog	60	1	Band (tricep extension)
19	Jog	60	45	Butt kicks
20	Jog	60	1	Dumb bells push and squeeze at end
21	Jog	60	45	High knees
22	Swim	60	56	Body weight
23	Jog	120	14	Running in place

\*For more exercise tips and workouts, consult the Aquatic Workout book provided in the box of the H2Xercise Kit.

# PROPULSION SYSTEM CONTROLS

## SMART WORKOUT REFERENCE GUIDE - TRAINING WORKOUTS

### ADVANCED TRAINING WORKOUT - 45 MIN.

Step	Mode	Seconds	Wave XP Swim Number	Recommended Exercise*
1	Swim	120	34	Breast stroke
2	Jog	120	34	Running in place
3	Jog	60	1	Step-up legs (60 sec. each leg)
4	Jog	60	45	Butt kicks
5	Jog	60	1	Leg raises (60 sec. each leg)
6	Jog	60	1	Arm circles forward/backward (30 sec. each direction)
7	Jog	60	45	High knees
8	Jog	60	1	Band (shoulder press)
9	Swim	120	45	Breast stroke
10	Jog	60	1	Band (chest press)
11	Swim	120	56	Free style swim
12	Jog	60	1	Step-up leg (60 sec. each leg)
13	Swim	120	45	Breast stroke
14	Jog	60	1	Band - bicep curl (60 sec. each arm)
15	Swim	120	56	Free style swim
16	Jog	60	1	Seated pull rows
17	Jog	60	1	Arm circles forward/backward (60 sec. each arm)
18	Swim	120	45	Breast stroke
19	Jog	60	1	Dumb bells push/pull
20	Swim	120	56	Free style swim
21	Jog	60	1	Band (tricep extension)
22	Jog	60	1	Step-up legs (60 sec. each leg)
23	Jog	60	45	Butt kicks
24	Jog	60	1	Dumb bells push and squeeze at end
25	Jog	60	1	Arm circles forward/backward (60 sec. each direction)
26	Jog	60	45	High knees
27	Swim	60	56	Body weight
28	Jog	120	14	Running in place

\*For more exercise tips and workouts, consult the Aquatic Workout book provided in the box of the H2Xercise Kit.

# PROPULSION SYSTEM CONTROLS

## SMART WORKOUT REFERENCE GUIDE - SWIM WORKOUTS

### BEGINNER SWIM WORKOUT - 25 MIN.

Step	Mode	Seconds	Wave XP Swim Number	Recommended Exercise*
1	Swim	60	41	Free Style Swim
2	Swim	60	41	Kick Chore
3	Swim	60	34	Catch Up Drill
4	Swim	60	47	Backstroke
5	Jog	60	1	Jog in Place
6	Swim	60	47	Free Style Swim
7	Swim	60	41	Kick Chore
8	Swim	60	34	Catch Up Drill
9	Swim	60	47	Backstroke
10	Jog	60	1	Jog in Place
11	Swim	60	47	Free Style Swim
12	Swim	60	41	Kick Chore
13	Swim	60	34	Catch Up Drill
14	Swim	60	47	Backstroke
15	Jog	60	1	Jog in Place
16	Swim	60	47	Free Style Swim
17	Swim	60	41	Kick Chore
18	Swim	60	34	Catch Up Drill
19	Swim	60	47	Backstroke
20	Jog	60	1	Jog in Place
21	Swim	60	47	Free Style Swim
22	Swim	60	41	Kick Chore
23	Swim	60	34	Catch Up Drill
24	Swim	60	47	Backstroke
25	Swim	60	41	Free Style Swim

### INTERMEDIATE SWIM WORKOUT - 25 MIN. 30 SEC.

Step	Mode	Seconds	Wave XP Swim Number	Recommended Exercise*
1	Swim	120	34	Free Style Swim
2	Swim	60	34	Fly Drill 2-2-2
3	Swim	60	1	W Fly 5 Strokes Fast + 10 55 FR EZ
4	Swim	120	1	Free Style Moderate Effort
5	Swim	60	45	Free Style Hard Effort
6	Jog	30	1	Jog in Place
7	Swim	60	1	Fly Drill 2-2-2
8	Swim	60	1	W Fly 5 Strokes Fast + 10 55 FR EZ
9	Swim	120	1	Free Style Moderate Effort
10	Swim	60	45	Free Style Hard Effort
11	Jog	30	1	Jog in Place
12	Swim	60	45	Fly Drill 2-2-2
13	Swim	60	1	W Fly 5 Strokes Fast + 10 55 FR EZ
14	Swim	120	1	Free Style Moderate Effort
15	Swim	60	45	Free Style Hard Effort
16	Jog	30	1	Jog in Place
17	Swim	60	45	Fly Drill 2-2-2
18	Swim	60	1	W Fly 5 Strokes Fast + 10 55 FR EZ
19	Swim	120	45	Free Style Moderate Effort
20	Swim	60	56	Free Style Hard Effort
21	Swim	120	14	Free Style Swim

\*For more exercise tips and workouts, consult the Aquatic Workout book provided in the box of the H2Xercise Kit.

DO NOT DIVE.

# PROPULSION SYSTEM CONTROLS

## SMART WORKOUT REFERENCE GUIDE - SWIM WORKOUTS

### ADVANCED SWIM WORKOUT - 41 MIN.

Step	Mode	Seconds	Wave XP Swim Number	Recommended Exercise*
1	Swim	180	47	Free Style Swim
2	Swim	60	47	Catchup with Steady Kick
3	Swim	60	60	Free Style Moderate Effort
4	Swim	60	76	Free Style Hard Effort
5	Swim	60	47	KKP Breast Drill
6	Swim	60	76	Breast Hard
7	Jog	60	1	Jog in Place
8	Swim	60	41	EZ Kick
9	Swim	60	47	Moderate Kick
10	Swim	60	54	Hard Kick
11	Swim	60	47	Catchup with Steady Kick
12	Swim	60	60	Free Style Moderate Effort
13	Swim	60	76	Free Style Hard Effort
14	Swim	60	47	KKP Breast Drill
15	Swim	60	76	Breast Hard
16	Jog	60	1	Jog in Place
17	Swim	60	41	EZ Kick
18	Swim	60	47	Moderate Kick
19	Swim	60	54	Hard Kick
20	Swim	60	47	Catchup with Steady Kick
21	Swim	60	60	Free Style Moderate Effort
22	Swim	60	76	Free Style Hard Effort
23	Swim	60	47	KKP Breast Drill
24	Swim	60	76	Breast Hard
25	Jog	60	1	Jog in Place
26	Swim	60	41	EZ Kick
27	Swim	60	47	Moderate Kick
28	Swim	60	54	Hard Kick
29	Swim	60	47	Catchup with Steady Kick
30	Swim	60	60	Free Style Moderate Effort
31	Swim	60	76	Free Style Hard Effort
32	Swim	60	47	KKP Breast Drill
33	Swim	60	76	Breast Hard
34	Jog	60	1	Jog in Place
35	Swim	60	41	EZ Kick
36	Swim	60	47	Moderate Kick
37	Swim	60	54	Hard Kick
38	Swim	120	41	Free Style Swim

\*For more exercise tips and workouts, consult the Aquatic Workout book provided in the box of the H2Xercise Kit.

# PROPULSION SYSTEM

## TECHNICAL INFORMATION

### CRITICAL REPLACEMENT COMPONENT PART NUMBERS:

**WARNING:** Items listed below shall only be replaced with identical components approved by Master Spas Engineering Department and installed by a qualified professional. Any change or alteration to the system components will cause a safety hazard and void the safety certification.

### PROPULSION SUCTION GRATES MISC. SPECIFICATIONS:

- Wall mount only
- Life span 7 years
- Tools required – No. 2 Phillips screwdriver
- Pulley system shall be 1:1 ratio only

**NOTE:** Fittings and fasteners should be observed for damage or tampering before each use of the swim spa.

- Propulsion suction grate assembly: X804490
- Propulsion grate fasteners (4 per grate): X717900

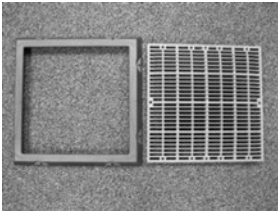

- Propeller
  - Wave XP ..... X400820 (Black, Discontinued)
  - Wave XP ..... X400823 (Blue, Backwards Compatible)
  - Wave XP PRO ..... X400820 (Black, Discontinued)
  - Wave XP PRO ..... X400823 (Blue, Backwards Compatible)
- Max. Frequency\*
  - Wave XP ..... 60Hz.
  - Wave XP PRO ..... 68Hz.

\*This is the certified maximum frequency. Actual frequency setting may vary.

**NOTE:** The propulsion system is designed to operate at any speed (Swim Number 1-100) for 30 minutes. The propulsion system can be operated for as much as 60 minutes continuous as long as the Swim Number is limited to 90 or below. If Swim Number exceeds 90 for more than 30 minutes, the propulsion motor could shut down to protect itself or trip the internal GFCI breaker. This is considered normal and can be avoided by operating the system as described above. If the system shuts down, verify that the internal GFCI is reset (on), allow time for the motor to cool, then operate as normal.

**WARNING:** In a domestic environment, this product may cause radio interference in which case supplementary mitigation measures may be required.



## FUSION AIR SOUND SYSTEM (IF EQUIPPED)

---

### REMOTE CONTROL POWER & SYNCING

**WARNING** – Never remain in your swim spa longer than 15 minutes per session when the water temperature is above 98°F. If you wish to spend more time in your swim spa, whether enjoying music, or just lounging, be sure to keep the swim spa water at or below body temperature (98.6°F).

**WARNING** – Prevent Electrocutation. Do not connect any auxiliary/external components to the system (i.e. cables, additional speakers, headphones, additional Audio/Video components, etc.).

### HANDHELD REMOTE CONTROL CHARGING

The remote has a built-in Polymer Lithium rechargeable battery and comes with a charging cable. Connect one end of the charging cable to the charging connection on remote control and connect the USB end of the charging cable to any USB charger (5V DC) for charging. Be sure charging connection is dry or allowed to dry before connecting to charge.



Make sure the remote has been charged before used. Do not leave remote under swim spa cover when not in use. Always store remote in dry location when not it in use.

### HANDHELD REMOTE CONTROL SYNCHRONIZING

The remote should already be paired from the factory, but if you need to synchronize the remote, follow the steps below:

1. Make sure BlueCube+ Media Player is powered ON (red LED).
2. Put the remote within 20 inches (0.5 meter) of the BlueCube+ Media Player.
3. Press and hold  MODE on remote control until the LCD shows “Pairing in Progress”. Release the button.
4. Within 2 seconds, the LCD will show “Paired”. If it fails to pair, the LCD will show “Retry again”. If this happens, wait 5 seconds and repeat steps above.

For any additional remote controls, you will also need to synchronize those remote controls to the BlueCube+ Media Player.

-  If the pairing process is not successful, try again to put your remote close to the remote receiver or charge the remote control if the battery is low.
-  Depending on the frequency of usage, the remote may drain its battery. Please charge the remote before use. If the LCD shows nothing, the battery has been drained and will need charging.
-  If you have lost or damaged your remote control and buy a new remote control, follow the above steps to pair the new remote control.

# FUSION AIR SOUND SYSTEM (IF EQUIPPED)

## EXPLANATION OF CONTROLS

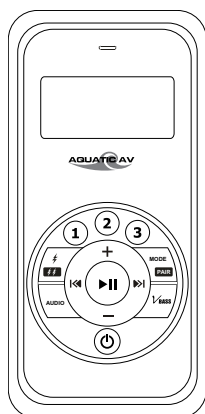

### STEREO OUTPUTS

Internal stereo module has capabilities for Bluetooth, FM Radio, AUX and USB. There is no external capabilities for AUX and USB. For this reason, these inputs will not be applicable when seen on remote. Simply use Mode to rotate back to either Bluetooth input or FM.

## REMOTE CONTROL

BUTTONS		BLUETOOTH	FM RADIO MODE
Power		Press once: Toggle from Operation mode to Standby mode or vice-versa. Press and hold: No function.	
Mode/Pair		Press once: Change mode. Press and hold: Synchronize remote control.	
Volume Up		Press once: Volume up Press and hold: Fast volume up	
Volume Down		Press once: Volume down Press and hold: Fast volume down	
Fast Forward		Press once: Next track Press and hold: Fast forward	Press once: +0.05kHz Press and hold: Scan up
Fast Rewind		Press once: Previous track Press and hold: Fast rewind	Press once: -0.05kHz Press and hold: Scan down
Play/Pause		Press once: Play/Pause Press and hold: No function	Press once: Toggle mute Press and hold: No function
1		Press once: No function Press and hold: No function	Press once: Listen to FM preset station 1 Press and hold: Set preset FM station 1
2		Press once: No function Press and hold: No function	Press once: Listen to FM preset station 2 Press and hold: Set preset FM station 2
3		Press once: No function Press and hold: No function	Press once: Listen to FM preset station 3 Press and hold: Set preset FM station 3
EXT Trigger		Press once: No function Press and hold: No function	Press once: No function Press and hold: No function
Audio		Press once: Enter Audio Menu Press and hold: Save & Exit Audio Menu	
VBass		Press once: Toggle VBass on/off Press and hold: No function	

## FUSION AIR SOUND SYSTEM (IF EQUIPPED)







---

### LISTENING TO DEVICES

#### PAIR WITH BLUETOOTH DEVICE

1. Switch on your Bluetooth device.
2. Select 'AQUATIC AV' from the list of available devices to pair (no password is needed).





#### LISTENING VIA BLUETOOTH DEVICE

1. Bluetooth mode will be activated once a Bluetooth device is paired in any mode. Use   (MODE) to change to the Bluetooth mode to listen to music.
2. Play the song from device and the sound will play through the BlueCube+ Media Player.
3. Press  (PLAY/PAUSE) to play/pause the song.
4. Press  /  (FAST REWIND/FAST FORWARD) buttons to play previous/next song file.
5. Press and hold  /  (FAST REWIND/FAST FORWARD) buttons to fast forward / fast rewind the song file.
6. Previous/next track and volume up/down can be controlled directly from your Bluetooth device or directly from the BlueCube+ Media Player remote control.

#### BLUETOOTH MULTI-LINK

A second Bluetooth device can pair to the BlueCube+ Media Player even when it has been paired to another Bluetooth device. The second Bluetooth device will be able to play once the first device has stopped playing.

#### ADJUST VOLUME LEVEL



1. Press  (VOLUME UP) once to increase the volume.
2. Press  (VOLUME DOWN) once to reduce the volume.
3. Press and hold either  or  (VOLUME UP or VOLUME DOWN) to increase or decrease audio volume continuously.

## FUSION AIR SOUND SYSTEM (IF EQUIPPED)

---

### LISTENING TO DEVICES



#### ENTER FM RADIO MODE

1. Press  (MODE) on the remote control to switch to FM radio mode.
2. Press  (PLAY/PAUSE) to mute or unmute the audio.



 If this is the first time you listen to FM radio, the default frequency will be 87.5MHz, as shown on the remote LCD.

 FM radio is only available when you are in FM Radio mode. Scan or seek FM radio Channels.



#### SCAN OR SEEK FM RADIO CHANNELS

1. Press  (FAST REWIND/FAST FORWARD) to seek another station.
2. Press once  (FAST REWIND/FAST FORWARD) to -0.05kHz or +0.05kHz to the frequency.





#### SAVING RADIO CHANNEL TO MEMORY

To save the current frequency to memory, press and hold the ,  or  for more than 2 seconds. The station will be stored into relevant button.

#### LISTENING TO SAVED RADIO MEMORY

Press the ,  or  preset button once to listen to the station stored in that button.

#### ADJUST VOLUME LEVEL

1. Press  (VOLUME UP) once to increase the volume.
2. Press  (VOLUME DOWN) once to reduce the volume.
3. Press and hold either  or  (VOLUME UP or VOLUME DOWN) to increase or decrease audio volume continuously.

# FUSION AIR SOUND SYSTEM (IF EQUIPPED)

## ADDITIONAL FEATURES

### AUDIO MENU

The BlueCube+ Media Player is equipped with an audio DSP (Digital Signal Processor) to provide preset listening experiences for different music types.

1. To enter audio menu, press **AUDIO** (AUDIO) button once on the remote control.
2. Each press of **AUDIO** (AUDIO) button will advance to the next audio setting as described on the right.
3. In the audio menu, press and hold **AUDIO** (AUDIO) to save and exit the audio menu back to the original mode.

If you have chosen preset equalizer (Rock, Classic, or Pop), the previous Bass & Treble settings will be overridden.

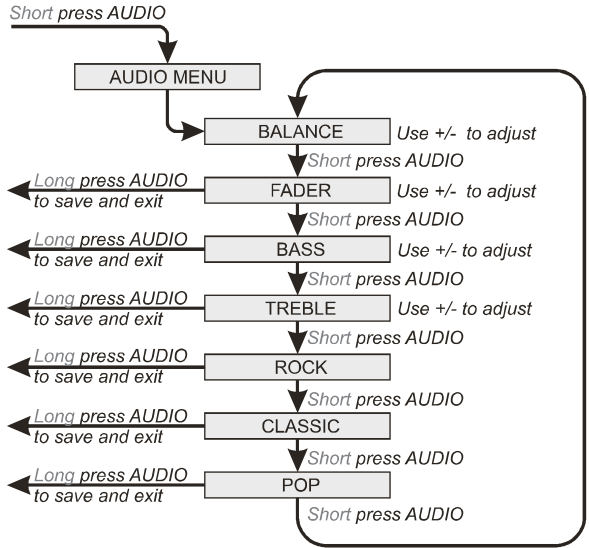

### VIRTUAL BASS (VBASS)

Virtual Bass (VBass) boosts the bass of the audio signal using the latest DSP technology and is particularly useful when used with very small speakers to create perceived bass frequencies of a much larger speaker.

Press **VBASS** (VBASS) once on the remote control to toggle it on or off.

**NOTE:** This regular maintenance for the Mast3rPur™ system is not covered under the warranty of the swim spa. Your Master Spas dealer or service organization can be contacted to schedule this maintenance.

**WARNING** – BEFORE PERFORMING ANY MAINTENANCE ON THE MAST3RPUR™ SYSTEM, MAKE SURE THE SWIM SPA IS SHUT DOWN.

Your Mast3rPur UV/Ozone system will require the following regular maintenance to allow continued, optimal operation.

- Quartz Tube (15) should be cleaned every six months of usage.
- UV-C Lamp (20) - needs replaced every 12 months of usage (during a drain and refill maintenance point falling between this time frame).
- Ozone Cell (5) - needs replaced every 12-18 months, during a swim spa drain and refill.  
**NOTE:** Please contact your Master Spas Dealer or service organization to perform this maintenance for you.

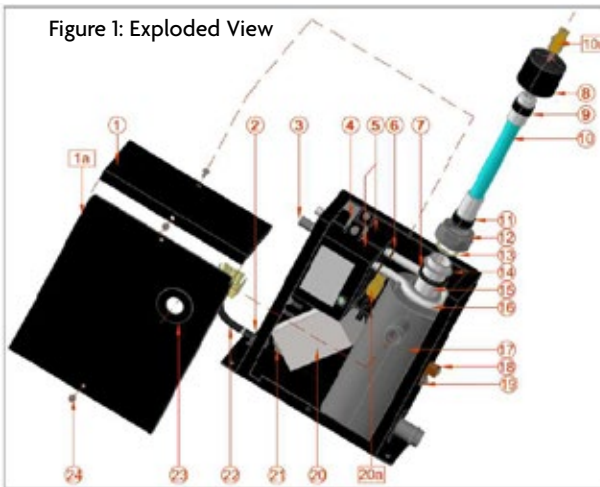

KEY	DESCRIPTION
1	ENCLOSURE TOP COVER
1a	ENCLOSURE FRONT COVER
2	STRAIN RELIEF
3*	AIR FILTER
4**	BRACKET: DUAL OZONE CELL
5***	OZONE CELL
6**	OZONE HOSE CLAMP
7	QUARTZ SEAL GASKET
8	BOOT COVER
9	UPPER CUSHION
10	UV LAMP
10a	LAMP CONNECTOR
11	LOWER CUSHION
12	COMPRESSION NUT
13	PLASTIC WASHER
14	COMPRESSION WASHER
15	QUARTZ TUBE
16**	OZONE CONNECTION HOSE
17	REACTION CHAMBER
18	GROUND LUG
19	HEX NUT
20	ELECTRONIC BALLAST
20a	BALLAST CONNECTOR
21	8 - 3/2x1/4" SCREW
22	POWER CORD
23	RUBBER WASHER
24	8 - 3/2x 5/16" SCREW

\*Item 3 as shown is for 2 ozone cells models.

\*\*Item 4, 6, 16 are for models with 2 ozone cells only.

\*\*\*Item 5 as shown is for 2 ozone cell models

## QUARTZ TUBE (6) CLEANING INSTRUCTIONS

**DANGER** – Turn the swim spa breaker to OFF position.

- Open the swim spa controller's cover and disconnect the unit from the swim spa controller.
- Drain the swim spa.

**WARNING** – Allow UV-C lamp (10) to cool down prior to removing from the unit.

**DANGER** – Never look at the lit UV-C lamp (10). This can cause severe eye damage or blindness.

- Remove water hoses from the unit as well as water inlet/outlet barbs and drain water out of the unit completely. Fold the water hoses and secure with clamp locking pliers to stop water from running out from the swim spa before removing them from the unit.
- Remove enclosure top cover (1) from the unit.
- Make sure to use latex glove when handling the UV-C lamp (10).

## MAST3RPUR™ (IF EQUIPPED)

---

- F. Disconnect UV-C lamp connector (10a) from ballast connector (20a).
- G. Slowly remove UV-C lamp (10) from quartz tube (15).
- H. Remove quartz seal compression nut (12).
- I. Use bare hands carefully to remove quartz seal gasket (7) and metal compression washer (14) that go over the quartz tube. Do not use any metal tools.
- J. Carefully remove the quartz tube (15).

**WARNING** – Be very careful when handling broken glass to avoid injury, and wipe off any spilled water inside the unit.

- K. Clean the quartz tube (15) with paper towel or dry cotton cloth. Do not use abrasive cleaner as that can scratch the quartz tube surface. Household tub and shower lime removal products can be used if needed. Rinse the quartz tube (15) with clean water to completely remove any cleaning products that were used.
- L. Install the quartz seal gasket (7) over the opened end of the new quartz tube (15). Place the new quartz tube (15) into the unit with the domed end first making sure it is inserted and seated inside the quartz end holder on the bottom of the reaction chamber. Only about 1/8" of quartz tube (15) will be exposed when it is seated correctly.
- M. Reinstall the compression washer (14) over the open end of the quartz tube (15). Push it against the quartz seal gasket (7).
- N. Reinstall and hand tighten the quartz seal compression nut (12) by turning it clockwise until it stops. Add another quarter of a turn by using a pair of Channel Lock pliers.
- O. Securely re-connect water hoses to the unit water inlet and outlet bars.
- P. Fill the swim spa. Make sure no water is dripping from the seal compression nut (12). If water is visible, STOP and tighten the compression nut another quarter of a turn with a pair of Channel Lock pliers to make sure it's completely sealed. Make sure there is no water leaking anywhere before proceeding to the next step.
- Q. Turn the breaker back on. Turn on the pump to circulate the water through the unit. Wait for 5 minutes and assure no water is dripping. If water is visible, STOP, fix the leak by repeating the quartz tube maintenance process from step (a) to step (o). Ensure no water dripping from the seal compression nut (12) or water inside quartz tube (15) before proceeding to next step.
- R. Turn the pump OFF, then turn the breaker OFF before proceeding to the next step.
- S. Slide the UV-C lamp (10) back inside the quartz tube (15).
- T. Reconnect the UV-C lamp connector (10a) to the ballast connector (20a). Make sure the connectors mate completely. Do not use force. Line up the locking tabs on connector (10a) with connector (10b).
- U. Reinstall the enclosure top cover (1) then secure with screws removed previously.
- V. Reconnect the water hoses back to the unit & secure with clamps.
- W. Reconnect the unit to the swim spa controller and reinstall the swim spa controller's cover.
- X. Turn ON the power to the swim spa.
- Y. Once power is activated you can check the LEDs to see if the unit is functioning. A solid green light indicates the unit is being provided power and should always be on. A solid blue light indicates that UV-C lamp is activated.

## MAST3RPUR™ (IF EQUIPPED)

---

**NOTE:** Only use a proper replacement UV-C lamp (10), which can be acquired through your Master Spas Dealer or service organization.

### UV-C LAMP (10) REPLACEMENT INSTRUCTIONS

**DANGER** – Turn the swim spa breaker to OFF position.

- A. Open the swim spa controller's cover and disconnect the unit from the swim spa controller.

**WARNING** – Allow UV-C lamp (10) to cool down prior to removing from the unit.

**DANGER** – Never look at the lit UV-C lamp (10). This can cause severe eye damage or blindness.

- B. Drain the swim spa.
- C. Remove water out of the Mast3rPur unit completely.
- D. Remove enclosure top cover (1).
- E. Make sure to use latex gloves when handling the UV-C lamp (10).
- F. Slowly disconnect the old UV-C lamp connector (10a) from ballast connector (20a).
- G. Slowly remove old UV-C lamp (10) from quartz tube (15). Save the upper cushion (9) and lower cushion (11).
- H. Install the upper cushion (9) and lower cushion (11) to the NEW UV-C lamp (10).
- I. Slide the NEW UV-C lamp (10) into the quartz tube (15).
- J. Reconnect the NEW UV-C lamp connector (10a) to the ballast connector (20a). Make sure the connectors mate completely. Do not use force. Line up locking tabs on connector (10a) to connector (20a).
- K. Reinstall the enclosure top cover (1) and secure with the screws removed previously.
- L. Reconnect the unit to the swim spa controller and reinstall the swim spa controller's cover.
- M. Turn ON the power to the swim spa.
- N. Once power is activated you can check the LEDs to see if the unit is functioning. A solid green light indicates the unit is being provided power and should always be on. A solid blue light indicates that UV-C lamp is activated.

**WARNING** – The UV-C lamp used in this unit contains mercury. Properly dispose the old UV-C lamp in accordance with disposal laws. See [www.lamprecycle.org](http://www.lamprecycle.org).



## MAST3RPUR - HEAT PUMP READY

### FACTORY PREPPED PLUMBING & HEAT PUMP INSTALLATION

If your swim spa is equipped with Mast3rPur option which includes a dedicated, energy efficient circulation pump, it will have a section of “Heat Pump Ready” plumbing present. This plumbing section is present to help simplify the installation process and reduce modifications to the original factory plumbing. This section of plumbing provides a prepped set of tees and a valve for use as output and input connection points for heat pump installation (external heating and/or cooling system). This plumbing configuration will be placed on the pressure / output side of the circulation pump, always downstream of the main spa control pack (the water must always flow through the spa control system before going through an external heating/cooling system), before the water flows back to the body of water. The following page provides a general diagram example of the plumbing. This heat pump ready section of plumbing will be located on either the left or right side of the swim spa, toward the equipment end, when standing at the 8’ seating and equipment end.

Scan applicable QR code or follow website links below to find more information:

**BWG**

[balboawatergroup.com/getdoc.cfm?id=2571](http://balboawatergroup.com/getdoc.cfm?id=2571)

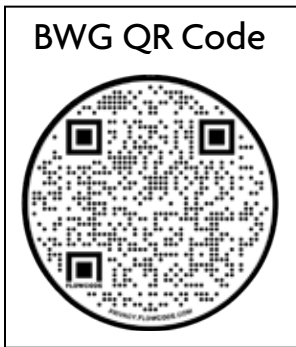

# MAST3RPUR - HEAT PUMP READY

## FACTORY PREPPED PLUMBING & HEAT PUMP INSTALLATION

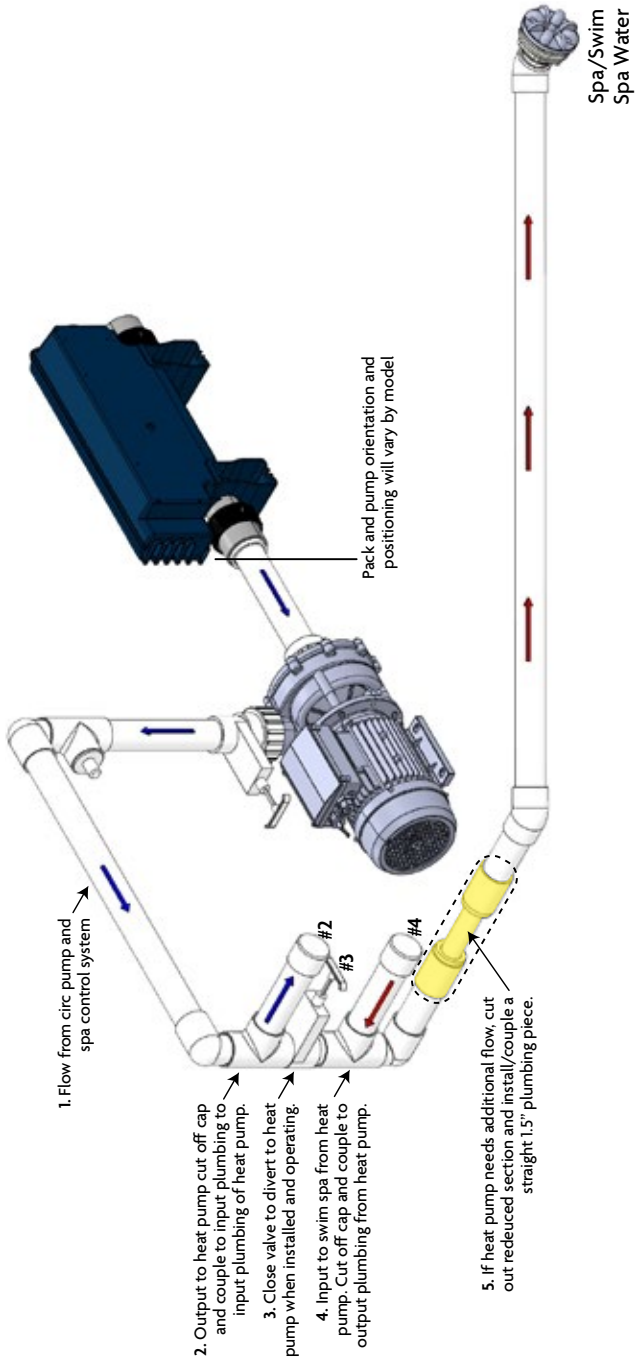

## **NONSLIP, COMFORT FLOOR SYSTEM (IF EQUIPPED)**

---

The exclusive Nonslip, Comfort Floor System is available as a premium option on swim spas manufactured by Master Spas to provide better grip, traction and comfort on both the steps and floor of the swim spa. Making our swim spas as safe and easy as possible to use while getting in, out, or exercising.

### **CARE & MAINTENANCE RECOMMENDATIONS:**

- Nonslip, Comfort Floor System cleans easily with soap, hot water and a brush (soft to medium bristle stiffness). Chlorine/bleach and water mixture, isopropyl rubbing alcohol or other household cleaner such as SoftScrub, Simple Green and 409 can be used to clean the pads.
- Be sure any soap or cleaning product is thoroughly rinsed from the pads and swim spa shell and this residue is removed before re-filling swim spa to prevent foaming.
- Always promptly attend to and clean any noticeable stains.

### **Never:**

- Treat your water with bromine if Nonslip, Comfort Floor System is installed on your swim spa.
- Allow stains to develop without promptly being attended to and cleaned.
- Clean with acid based cleaning products.
- Use acetone or mineral spirits on Nonslip, Comfort Floor System or swim spa shell as damage caused to the swim spa shell from these chemicals would not be warranted.

**NOTE:** The Nonslip, Comfort Floor System is not compatible with the use of bromine sanitizer. Do not use this chemical if your swim spa is equipped with the Nonslip, Comfort Floor System.

# INTERNATIONAL LIMITED WARRANTY

## MICHAEL PHELPS SIGNATURE SWIM SPAS

MICHAEL PHELPS  
SIGNATURE SWIM SPAS™

BY MASTER SPAS

**NOTE: This International Limited Warranty applies to residential use outside of the United States and Canada.**

### 10 YEARS - SWIM SPA STRUCTURE

Master Spas warrants to the original retail purchaser the structural integrity of the spa against water loss from the spa due to defects in material or workmanship, in the spa structure for a period of 10 years from the date of the original retail purchase. Master Spas will either repair, including the parts and labor to repair the spa structure or replace the nonconforming Spa Structure. In the event of replacement, the cost of labor and equipment for removal and replacement of the unit is the sole responsibility of the Purchaser.

### 7 YEARS - SHELL SURFACE

Master Spas warrants to the original retail purchaser that the acrylic finish will not blister, crack or delaminate for a period of 7 years from the date of original retail purchase as a result of defects in material or workmanship. Master Spas will either repair, including the parts and labor to repair the shell surface or replace the nonconforming shell. In the event of replacement, the cost of labor and equipment for removal and replacement of the unit is the sole responsibility of the Purchaser. There is no Shell Surface Warranty on blemished units.

### 5 YEARS - EQUIPMENT

Master Spas warrants to the original retail purchaser the swim spa equipment (pumps, heater and control system) should a component of the Equipment Pack fail or malfunction due to defects in material and workmanship, for a period of 5 years from the date of the original retail purchase. Master Spas will either repair or replace the applicable component, including replacement parts and labor to install them (parts and labor).

### 5 YEARS - PLUMBING

Master Spas warrants to the original retail purchaser for a period of 5 years from the date of original retail purchase that the plumbing of the swim spa will not leak due to defects in material and workmanship (Master Spas will provide replacement parts and labor to repair or replace the applicable components).

### 5 YEARS - JETS

Jet internals are warranted against malfunctions due to defects in material for a period of 5 years from the date of original retail purchase (Master Spas will provide replacement jet internal parts only). The cost of shipping and installation of any jet internals is the sole responsibility of the purchaser. After initial delivery and startup, discoloring or fading of the plastics, corrosion of any stainless steel components and sticking/seizing of the adjustable jet internals or their spinning nozzles is specifically excluded from these warranty terms.

### 5 YEARS/LIFETIME - SKIRTING\* (MasterTech™ / DuraMaster Polymer™)

Master Spas warrants to the original retail purchaser that the optional MasterTech™ skirting will not crack or rip due to defects in material for a period of 5 years from the date of the original retail purchase. Master Spas warrants to the original retail purchaser only that the DuraMaster Polymer™ skirting will not crack or rip for the life of the swim spa. Bowing that can occur under some conditions is considered normal and excluded by this limited warranty. Normal wear and weathering that occur overtime are not defects. If the skirting on the swim spa fails due to defects in materials or workmanship, Master Spas will replace the applicable skirting components (parts only). The cost of shipping and installation of any replacement skirting is the sole responsibility of purchaser.

\*If equipped. Options vary by model.

# **INTERNATIONAL LIMITED WARRANTY**

## **MICHAEL PHELPS SIGNATURE SWIM SPAS**

**MICHAEL PHELPS  
SIGNATURE SWIM SPAS™**

 BY MASTER SPAS

**NOTE: This International Limited Warranty applies to residential use outside of the United States and Canada.**

### **3 YEARS - WAVE PROPULSION SYSTEM\***

Master Spas warrants to the original retail purchaser that the Wave Propulsion System (propeller drive and all associated components/mountings that operate it including, but not limited to, the Wave control panel, motor, and internally wired GFCI) will not malfunction due to defects in material and workmanship for a period of 3 years from the date of the original retail purchase. Master Spas will repair or replace the applicable components, including labor to install (parts and labor).

### **3 YEARS - NONSLIP COMFORT FLOOR SYSTEM\***

Master Spas warrants to the original retail purchaser that the factory installed Nonslip Comfort Floor System will not separate from the floor of the swim spa for a period of 3 years. In the event the adhesion fails causing the pad to come free from the swim spa shell or separation of the pad material occurs; Master Spas will either repair or replace the applicable component(s) including parts and labor. Normal discoloring, fading, or wear of the Nonslip Comfort Floor System is not covered by this limited warranty. Causes of these failures include but are not limited to water conditions, chemical levels or UV exposure. See the swim spa owner's manual for proper water chemistry levels, water maintenance and swim spa care for best longevity of your Nonslip Comfort Floor System. Damage such as cuts, gouges and scrapes caused to the pad from objects or exercise equipment brought in to the swim spa would not be covered by this limited warranty. Nonslip Comfort Floor System purchased and installed after the swim spa was manufactured by Master Spas is not covered by this limited warranty.

### **1 YEAR - LED LIGHT SYSTEM\***

Master Spas warrants to the original retail purchaser, for a period of 1 year from the date of original retail purchase that the optional, factory installed LED light system will not malfunction due to defects in workmanship and materials (parts and labor). If the LED light system or any component thereof fails due to defects in material or workmanship, Master Spas will either repair or replace the applicable components.

### **1 YEAR - OZONATOR\***

Master Spas warrants to the original retail purchaser that the factory installed ozonator will not malfunction due to defects in materials or workmanship for a period of 1 year from the date of original retail purchase. If the ozonator malfunctions due to a defect in materials or workmanship, Master Spas will either repair or replace the applicable components including parts and labor.

### **1 YEAR - MAST3RPUR SYSTEM\***

Master Spas warrants to the original retail purchaser that the factory installed Mast3rPur system will not malfunction due to defects in materials or workmanship for a period of 1 year from the date of original retail purchase. If the Mast3rPur system malfunctions due to a defect in materials or workmanship, Master Spas will either repair or replace the applicable components including parts and labor.

### **1 YEAR - AUDIO EQUIPMENT\***

Master Spas warrants to the original retail purchaser, the optional stereo and enclosure components within the audio system against malfunctions due to defects in material and workmanship for a period of 1 year (parts). This limited warranty on all optional Audio Equipment covers labor for a period of 1 year from the date of original retail purchase. After 1 year, the purchaser is solely responsible for any labor costs associated with the repair or replacement of any applicable audio components. Master Spas shall not be responsible for any damages or losses to any accessories (not supplied by Master Spas), including but not limited to iPods or similar systems, caused by a defect or malfunction of any Master Spas supplied component.

# INTERNATIONAL LIMITED WARRANTY

---

## EXCLUSIONS AND LIMITATIONS

### EXCLUSIONS

This limited warranty is enforceable only by the original retail purchaser from the date of original retail purchase but is voidable if the entire purchase price has not been paid to the retailer dealer. Light bulbs, light lenses, fuses, overlays/labels, covers, swim spa pillows, exercise kit/equipment, unwired factory supplied GFCI (US & Canada H2X Challenger only) or any dealer installed accessories are specifically excluded from this limited warranty. All warranties are void if the swim spa is placed in commercial service. Any spa in service at a residential rental property, the warranty periods are reduced as follows: any warranty period of 4 years or more, are reduced to 2 years; any warranty period of 2 to 3 years, are reduced to 1 year; any warranty periods of 1 year or less, remain the same. Normal wear and weathering of finishes and components are not defects and specifically excluded from this limited warranty. In the event it is necessary to remove the swim spa from the residential premises to repair or replace any warrantable item, any and all cost of swim spa removal and replacement including but not limited to removal of the original swim spa and transportation of the replacement swim spa, damages to landscaping, decking, fencing or other structural alteration, or any cost related to obtaining access to the swim spa are the sole responsibility of the purchaser. Swim spa covers are not included or covered by this swim spa warranty. Freight/shipping costs for any warrantable replacement item is the sole responsibility of the purchaser.

### LIMITATIONS

This limited warranty is voidable if the spa has been subject to misuse, alteration or attempted alteration, repairs or attempted repairs by a non-approved service center or if a failure or malfunction is due to improper installation, improper water chemistry, improper maintenance or lack of normal maintenance as prescribed in the Master Spas Owner's Manual, an act of God, weather conditions, animals, rodents, pests or any damage from causes beyond the control of Master Spas. Misuse or abuse shall mean operation of the spa other than in conformity with the Master Spas Owner's Manual. Such misuse and abuse shall include but not be limited to the following:

- Damage of the swim spa surface and components caused by leaving the swim spa uncovered or due to covering the swim spa with plastic film of any kind.
- Damage to the swim spa surface and components caused by use of a non-insulating cover or an unapproved cover not manufactured by Master Spas when the swim spa is subject to weather conditions and sun.
- Damage to the swim spa surface and components caused by contact with unapproved cleaners or solvents.
- Damage caused by operation of the swim spa at water temperatures outside the range of 34° F - 104° F.
- Freeze damage.
- Damage caused by unapproved sanitizers such as calcium hypochlorite, sodium hydroxide, "tri-chlor" type chlorines or any sanitizing chemical that may remain undissolved on the swim spa surface.
- Damages or malfunction due to a dirty, clogged, calcified filters or use of an unapproved filter cartridge.
- Damages or malfunction caused by failure to provide even, proper support for the swim spa.
- Damages or malfunction caused during installation of the swim spa.
- Damages or malfunction caused by use of unapproved filter cartridges.

# INTERNATIONAL LIMITED WARRANTY

## EXCLUSIONS AND LIMITATIONS

### WARRANTY REGISTRATION AND WARRANTY CLAIM PROCEDURE

The original retail purchaser should register their swim spa purchase within 10 days from the date of original retail purchase to establish proof of purchase with Master Spas. Failure to register does not void this limited warranty but, upon any warranty claim, proof of purchase must first be provided to confirm original retail purchase date to the original retail purchaser. Swim Spa Registration can be submitted online at [www.masterspas.com/resources](http://www.masterspas.com/resources). In the event of a warranty claim of a defect or malfunction covered under the provisions of this limited warranty, the original retail purchaser must first notify in writing the retail dealer who sold the swim spa within ten (10) days of the initial malfunction or discovery of defect. If the retail dealer does not provide service, then the purchaser should contact Master Spas customer service department, via the web site, or provide written notice of the malfunction or defect at the address below. Upon notice of the warranty claim, the retail dealer or an approved independent service center representative will arrange inspection of the swim spa with the retail purchaser to determine if the claimed malfunction or defect is a covered malfunction or defect under this limited warranty. If it is determined that the malfunction is not covered by this limited warranty, the cost of the service call is the sole responsibility of the purchaser. If it is determined that the malfunction or defect is covered under this limited warranty, Master Spas through the retail dealer, or approved independent service center will repair or replace the covered item. In the event of swim spa replacement, the replacement swim spa will carry the balance of the original swim spa warranty from the original retail purchase date. Master Spas reserves the right for its dealers or approved service centers to collect from the retail purchaser reasonable travel expenses. In addition, access charges will be assessed if the swim spa is not reasonably accessible for inspection, repair or replacement. This limited warranty is extended only to the original retail purchaser and is not transferable. This limited warranty becomes void upon the transfer of ownership of the swim spa or moving of the swim spa to a different location.

### DISCLAIMERS

MASTER SPAS LLC, NEITHER ASSUMES NOR DO WE AUTHORIZE ANY OTHER PERSON TO ASSUME FOR US, ANY OTHER LIABILITY IN CONNECTION WITH THE SALE OF SWIM SPAS MANUFACTURED BY MASTER SPAS. THIS LIMITED WARRANTY SHALL BE THE EXCLUSIVE REMEDY AVAILABLE TO A PURCHASER AND MASTER SPAS SHALL NOT BE LIABLE FOR ANY INCIDENTAL OR CONSEQUENTIAL DAMAGES RESULTING FROM MISUSE OF THE SWIM SPA OR CAUSED BY ANY DEFECT, FAILURE OR MALFUNCTION OF THE SWIM SPA, WHETHER A CLAIM IS BASED UPON WARRANTY, CONTRACT, NEGLIGENCE OR OTHERWISE. SOME STATES DO NOT ALLOW THE EXCLUSION OF INCIDENTAL OR CONSEQUENTIAL DAMAGES, SO THIS LIMITATION MAY NOT APPLY TO YOU.

TO THE EXTENT PERMITTED BY APPLICABLE LAW, THIS LIMITED WARRANTY SPECIFICALLY EXCLUDES ANY AND ALL IMPLIED WARRANTIES OF MERCHANTABILITY AND/OR FITNESS FOR A PARTICULAR PURPOSE, OTHERWISE ALL IMPLIED WARRANTIES ARE LIMITED IN DURATION TO TWO (2) YEARS FROM THE ORIGINAL DATE OF RETAIL PURCHASE. SOME STATES DO NOT ALLOW THE LIMITATION OF THE DURATION OF IMPLIED WARRANTIES, SO THIS LIMITATION MAY NOT APPLY TO YOU. THERE ARE NO OTHER WARRANTIES, EITHER EXPRESSED OR IMPLIED, OF ANY KIND OR NATURE WHICH EXTEND BEYOND THE DESCRIPTION ON THE FACE HEREOF. SOME STATES DO NOT ALLOW THE LIMITATIONS OF REMEDIES SO THESE LIMITATIONS MAY NOT APPLY TO YOU.

IF YOUR SWIM SPA IS DESIGNATED BY MASTER SPAS AS A "BLEM" OR AS "BLEMISHED", THE SHELL SURFACE IS NOT WARRANTED AND THE SWIM SPA IS PURCHASED "AS IS" REGARDING ANY COSMETIC BLEMISHES.



6927 Lincoln Parkway, Fort Wayne IN 46804  
800 860 7727 [masterspas.com](http://masterspas.com)











Customer Service: [www.masterspas.com/resources](http://www.masterspas.com/resources)

6927 Lincoln Parkway, Fort Wayne, IN 46804  
800.860.7727 [CustomerService@MasterSpas.com](mailto:CustomerService@MasterSpas.com)

Stay Connected, Keep in Touch      @MasterSpas #masterspas

## INTERNATIONAL VERSION

Master Spas® reserves the right to change product specifications or features without notice. Master Spas is a manufacturer of spas and related products, and we stand behind every product we produce pursuant to those representations which are stated in our written limited warranty. Your dealer is an independent businessperson or company and not an employee or agent of Master Spas, LLC. We cannot and do not accept any responsibility or liability for any other representations, statements or contracts made by any dealer beyond the provisions of our written limited warranty. Master Spas, Master Blaster, and EcoPur are registered trademarks of Master Spas, LLC. Michael Phelps Signature Swim Spas, The Ultimate Relaxation Machine, Mast3rPur, MasterTech, and DuraMaster are all trademarks of Master Spas, LLC. Patents: [masterspas.com/patents](http://masterspas.com/patents)