

LEGACY
WHIRLPOOL

OWNER'S MANUAL

MASTER SPAS OWNER'S MANUAL

Welcome To Ultimate Relaxation!

Thank you for choosing your new spa built by Master Spas. Please read the entire Owner's Manual before installing and using your spa. The goal of this manual is to provide you with safety and operational information plus some tips that will help you enjoy your spa to its fullest.

At the time of print, this manual is accurate in its information. Master Spas reserves the right to change or improve its product without prior notice. To check on updates or for other information, please visit www.masterspas.com and follow the links to the customer support section.

Record Of Ownership

Name _____

Address _____

City _____ State _____ Zip _____

Phone # (____) _____ - _____ Date Purchased ____ / ____ / ____

Model _____ Serial # _____

Dealer Name _____

Service Tech Rep _____

Serial Number Location

The serial number for your spa is located near the filter area, on the spa system pack, or on the listing plate on the skirting. It is a seven digit number. Ex. 1612345

Register Your Spa

Please be sure to register your spa so we can efficiently assist with any questions you may have. Until your spa has been registered, Master Spas Inc. will not have record of your ownership.

To register your spa, visit www.MasterSpas.com and access our Owner's Support within the Resources tab link on the page. This area will offer online registration capability along with other support information.



6927 Lincoln Parkway
Fort Wayne, Indiana 46804
www.masterspas.com

TABLE OF CONTENTS

Table of Contents	2
Safety Instructions	3-10
Glossary of Spa Terminology	11-13
Site Preparation / General Guidelines	14-16
Installation Instructions	17-18
The Advantages of Eco-Pur Filtration	19
Water Chemistry Terms You Should Know	20-21
Why are Chemicals Important in a Spa	22
Water Maintenance	23-26
Start-Up	23
Schedule	24-25
Trouble-shooting Guide	26
Regular Maintenance Procedures	27-31
Spa Trouble-shooting Guide	32-33
Winterizing & Storing your Spa	34
Spa Care and Maintenance Record	35-37
Electrical Requirements	39-42
Configuration 1	39-40
Configuration 2	41-42
Model Specifications	42
Spa Controls – 120V Models	43-46
Spa Controls	47-56
WI-Fi Module (if equipped)	57
Deluxe Fusion Air Stereo Option (if equipped)	58-60

SAFETY INSTRUCTIONS

SAVE THESE INSTRUCTIONS

Included with your new spa is a safety sign. The sign is for you and your guest's protection and is suitable for outdoor use in wet locations. The sign should be placed in a location visible to all users of the spa.

Please take time to point out the physical location of the safety sign and the importance of the safety precautions displayed on the safety sign to all of your guests. Remember, your safety and the safety of anyone who enjoys the use of your spa is our utmost concern.

The sign should be mounted with screws or another type of permanent fastener. Additional or replacement signs can be obtained from your dealer or direct from the factory.

INTRODUCTION

It's time to relax! You now have your very own portable spa by Master Spas, Inc. By fully understanding the operation of each of the features of your new Master Spa, you will be assured of many years of hassle-free, hot water therapy and fun.

Your safety is of paramount importance to the MasterSpas family. We urge you to read and become thoroughly familiar with all safety aspects addressed in this manual.

Through reading and totally understanding the important information in your owner's manual, you will realize that you now own **THE ULTIMATE RELAXATION MACHINE!**

NO DIVING

**DANGER: DIVING MAY
RESULT IN SERIOUS
INJURY OR DEATH.**



IMPORTANT SAFETY INSTRUCTIONS

When installing and using this electrical equipment, basic safety precautions should be observed including the following:

READ AND FOLLOW ALL INSTRUCTIONS

WARNING – To reduce the risk of injury, do not permit children to use this product unless they are closely supervised at all times.

A wire conductor is provided on this unit to connect a minimum 6 AWG (13.302mm²) solid copper conductor between this unit and any metal equipment, metal enclosures of electrical equipment, metal water pipe, or conduit within 5 feet (1.5m) of the unit

(For cord-connected/convertible units)

DANGER – Risk of injury.

- a) Replace damaged cord immediately.
- b) Do not bury cord.
- c) Connect to a grounded, grounding type receptacle only.

(For units intended for indoor use only)

WARNING – For indoor use only. This unit is not intended for outdoor use.

(For units intended for outdoor use only)

WARNING – For outdoor use only. This unit is not intended for indoor use.

SAFETY INSTRUCTIONS

NO DIVING

**DANGER: DIVING MAY
RESULT IN SERIOUS
INJURY OR DEATH.**



IMPORTANT SAFETY INSTRUCTIONS (CONT.)

(For units with GFCI)

WARNING – This product is provided with a ground-fault circuit interrupter located on the front panel of selected swim spas and on the power cord of 120 volt convertible spas. The GFCI must be tested before each use. With the product operating, open the service door. When the product stops operating, this merely indicates that the door is equipped with an electrical interlock. Next, push the test button on the GFCI and close the service door. The product should not operate. Now open the service door, push the reset button on the GFCI and close the service door. The product should now operate normally. When the product fails to operate in this manner, there is a ground current flowing indicating the possibility of an electric shock. Disconnect the power until the fault has been identified and corrected.

DANGER – Risk of Accidental Drowning. Extreme caution must be exercised to prevent unauthorized access by children. To avoid accidents, ensure that children cannot use this spa unless they are supervised at all times.

DANGER – Risk of Injury. The suction fittings in this spa are sized to match the specific water flow created by the pump. Should the need arise to replace the suction fittings or the pump, be sure that the flow rates are compatible.

Never operate spa if the suction fittings are broken or missing. Never replace a suction fitting with one rated less than the flow rate marked on the original suction fitting.

DANGER – Risk of Electric Shock. Install at least 5 feet (1.5m) from all metal surfaces. As an alternative, a spa may be installed within 5 feet of metal surfaces if each metal surface is permanently connected by a minimum 8AWG (8.4mm²) solid copper conductor to the wire connector on the terminal box that is provided for this purpose.

DANGER – Risk of Electric Shock. Do not permit any electric appliance, such as a light, telephone, radio, or television, within 5 feet (1.5 m) of a spa.

WARNING – To reduce the risk of injury:

- a) The water in a spa should never exceed 40°C (104°F). Water temperatures between 38°C (100°F) and 40°C (104°F) are considered safe for a healthy adult. Lower water temperatures are recommended for young children and when spa use exceeds 10 minutes.

SAFETY INSTRUCTIONS

NO DIVING

**DANGER: DIVING MAY
RESULT IN SERIOUS
INJURY OR DEATH.**



IMPORTANT SAFETY INSTRUCTIONS (CONT.)

- b) Since excessive water temperatures have a high potential for causing fetal damage during the early months of pregnancy, pregnant or possibly pregnant women should limit spa water temperatures to 38°C (100°F).
- c) Before entering a spa, the user should measure the water temperature since the tolerance of water temperature- regulating devices varies.
- d) The use of alcohol, drugs, or medication before or during spa use may lead to unconsciousness with the possibility of drowning.
- e) Obese persons and persons with a history of heart disease, low or high blood pressure, circulatory system problems, or diabetes should consult a physician before using a spa.
- f) Persons using medication should consult a physician before using a spa since some medication may induce drowsiness while other medication may affect heart rate, blood pressure, and circulation.

(For spas with a gas heater)

WARNING – Risk of Suffocation. This spa is equipped with a gas heater and is intended for outdoor use only unless proper ventilation can be provided for an indoor installation.

HYPERTHERMIA

Hyperthermia occurs when the internal temperature of the body reaches a level several degrees above the normal body temperature of 98.6°F (37°C).

THE SYMPTOMS OF HYPERTHERMIA INCLUDE:

- Dizziness • Fainting • Drowsiness • Lethargy
- Increase in Internal Body Temperature

THE EFFECTS OF HYPERTHERMIA INCLUDE:

Unawareness of Impending Hazard • Failure to Perceive Heat • Failure to Recognize the Need to Exit Spa • Physical Inability to Exit Spa • Fetal Damage in Pregnant Women • Unconsciousness Resulting in a Danger of Drowning

SAFETY INSTRUCTIONS

NO DIVING

**DANGER: DIVING MAY
RESULT IN SERIOUS
INJURY OR DEATH.**



IMPORTANT SAFETY INSTRUCTIONS (CONT.)

DANGER – To reduce the risk of injury to persons, do not remove the suction grate. Suction through drains and skimmers is powerful when the jets in the spa are in use. Damaged covers can be hazardous to small children and adults with long hair. Should any part of the body be drawn into these fittings, turn off the spa immediately. As a precaution, long hair should not be allowed to float in the spa.

WARNING – Install the spa so that water can be easily drained out of the compartment containing electrical components so as not to damage equipment. When installing the spa make sure to allow for an adequate drainage system to deal with any overflow water. Please allow for at least 3 feet of clearance around the perimeter of the spa to provide enough room to access for servicing. Contact your local dealer for their specific requirements.

WARNING – The spa should be covered with an approved locking cover when not in use, to prevent unauthorized entry and injuries.

WARNING – People with infections, sores or the like should not use the spa. Warm and hot water temperatures may allow the growth of infectious bacteria if not properly disinfected.

CAUTION – Safe temperatures for swimming or aquatic exercise is around 80°F (26.7°C).

CAUTION – Risk of Electrical Shock. Do not leave audio compartment open. Audio CD controls are not to be operated while inside the spa.

CAUTION – Replace components only with identical components.

WARNING – Risk of Electric Shock. Do not connect any auxiliary components (for example, additional speakers, headphones, additional audio/ video components etc.) to the system. These units are not provided with an outdoor antenna.

Do not service this product yourself as opening or removing covers may expose you to dangerous voltage or other hazards. Refer all servicing to qualified service personnel.

If the power supply cord(s) are damaged, water is entering the speaker, audio compartment, or any other component in the electrical equipment compartment area, the protective shield is showing signs of deterioration, or there are signs of other potentially hazardous damage to the unit, turn off the circuit breaker from the wall and refer servicing to qualified personnel.

NO DIVING	DANGER: DIVING MAY RESULT IN SERIOUS INJURY OR DEATH.	
------------------	--	---

IMPORTANT SAFETY INSTRUCTIONS (CONT.)

The unit should be subjected to periodic routine maintenance once every quarter to make sure that the it is operating properly.

DANGER – Risk of Electric Shock. A green colored terminal or a terminal marked G, GR, Ground, Grounding or the symbol shown in Figure 14.1 of UL 1563 is located inside the supply terminal box or compartment. To reduce the risk of electric shock, this terminal must be connected to the grounding means provided in the electric supply service panel with a continuous copper wire equivalent in size to the circuit conductors supplying this equipment.

At least two lugs marked “Bonding Lugs” are provided on the external surface or on the inside of the supply terminal box or compartment. To reduce the risk of electric shock, connect the local common bonding grid in the area of the spa to these terminals with an insulated or bare copper conductor not smaller than 8AWG.

All field installed metal components such as rails, ladders, drains, or other similar hardware within 3m of the spa shall be bonded to the equipment grounding bus with copper conductors not smaller than 8AWG.

SAVE THESE INSTRUCTIONS

SAFETY INSTRUCTIONS

WARNING: CHILDREN SHOULD NOT USE SPAS OR HOT TUBS WITHOUT ADULT SUPERVISION

AVERTISSEMENT: NE PAS LAISSER LES ENFANTS UTILISER UNE CUVE DE RELAXATION SANS SURVEILLANCE

WARNING: DO NOT USE SPAS OR HOT TUBS UNLESS ALL SUCTION GUARDS ARE INSTALLED TO PREVENT BODY AND HAIR ENTRAPMENT.

AVERTISSEMENT: POUR ÉVITER QUE LES CHEVEUX OU UNE PARTIE DU CORPS PUISSENT ÊTRE ASPIRES, NE PAS UTILISER UNE CUVE DE RELAXATION SI LES GRILLES DI PRISE D'ASPIRATION NE SONT PAS TOUTES EN PLACE

WARNING: PEOPLE USING MEDICATIONS AND/OR HAVING AN ADVERSE MEDICAL HISTORY SHOULD CONSULT A PHYSICIAN BEFORE USING A SPA OR HOT TUB.

AVERTISSEMENT: LES PERSONNES QUI PRENNENT DES MÉDICAMENTS OU ONT DES PROBLÈMES DE SANTÉ DEVRAIENT CONSULTER UN MÉDECIN AVANT D'UTILISER UNE CUVE DE RELAXATION

WARNING: PEOPLE WITH INFECTIOUS DISEASES SHOULD NOT USE A SPA OR HOT TUB

AVERTISSEMENT: LES PERSONNES ATTEINTES DE MALADIES INFECTIEUSES NE DEVRAIENT PAS UTILISER UNE CUVE DE RELAXATION

WARNING: TO AVOID INJURY EXERCISE CARE WHEN ENTERING OR EXITING THE SPA OR HOT TUB.

AVERTISSEMENT: POUR ÉVITER DES BLESSURES, USER DE PRUDENCE EN ENTRANT DANS UNE CUVE DE RELAXATION ET EN SORTANT

WARNING: DO NOT USE DRUGS OR ALCOHOL BEFORE OR DURING THE USE OF A SPA OR HOT TUB TO AVOID UNCONSCIOUSNESS AND POSSIBLE DROWNING

AVERTISSEMENT: POUR ÉVITER L'ÉVANOUISSEMENT ET LA NOYADE ÉVENTUELLE, NE PRENDE NI DROGUE NI ALCOOL AVANT D'UTILISER UNE CUVE DE RELAXATION NI QUAND ON S'Y TROUVE

WARNING: PREGNANT OR POSSIBLY PREGNANT WOMEN SHOULD CONSULT A PHYSICIAN BEFORE USING A SPA OR HOT TUB.

AVERTISSEMENT: LES FEMMES ENCEINTES, QUE LEUR GROSSESSE SOIT CONFIRMÉE OU NON, DEVRAIENT CONSULTER UN MÉDECIN AVANT D'UTILISER UNE CUVE DE RELAXATION

WARNING: WATER TEMPERATURE IN EXCESS OF 38°C MAY BE INJURIOUS TO YOUR HEALTH

AVERTISSEMENT: IL PEUT ÊTRE DANGEREUX POUR LA SANTÉ DE SE PLONGER DANS DE L'EAU A PLUS DE 38°C

WARNING: BEFORE ENTERING THE SPA OR HOT TUB MEASURE THE WATER TEMPERATURE WITH AN ACCURATE THERMOMETER

AVERTISSEMENT: AVANT D'UTILISER UNE CUVE DE RELAXATION MESURER LA TEMPÉRATURE DE L'EAU À L'AIDE D'UN THERMOMÈTRE PRÉCIS

SAFETY INSTRUCTIONS

WARNING: DO NOT USE A SPA OR HOT TUB IMMEDIATELY FOLLOWING STRENUOUS EXERCISE

AVERTISSEMENT: NE PAS UTILISER UNE CUVE DE RELAXATION IMMÉDIATEMENT APRÈS UN EXERCISE FATIGANT

WARNING: PROLONGED IMMERSION IN A SPA OR HOT TUB MAY BE INJUROUS TO YOUR HEALTH

AVERTISSEMENT: L'UTILISATION PROLONGÉE D'UNE CUVE DE RELAXATION PEUT ÊTRE DANGEREUSE POUR LA SANTÉ

WARNING: DO NOT PERMIT ELECTRIC APPLIANCES (SUCH AS LIGHT, TELEPHONE, RADIO, OR TELEVISION) WITHIN 1.5 M OF THIS SPA OR HOT TUB

AVERTISSEMENT: NE PAS PLACER D'APPAREIL ÉLECTRIQUE (LUMINAIRE, TÉLÉPHONE, RADIO, TÉLÉVISEUR, ETC) À MOINS DE 1.5 M DE CETTE CUVE DE RELAXATION

CAUTION: MAINTAIN WATER CHEMISTRY IN ACCORDANCE WITH MANUFACTURER'S INSTRUCTION

ATTENTION: LA TENEUR DE L'EAU EN MATIÈRES DISSOUTES DOIT ÊTRE CONFORME AUX DIRECTIVES DU FABRICANT

Hyperthermia occurs when the internal temperature of the body reaches a level several degrees above the normal body temperature of 37°C (98.6°F). The symptoms of hyperthermia include drowsiness, lethargy, and an increase in the internal temperature of the body. The effects of hyperthermia include

- (a) unawareness of impending hazard;
- (b) failure to perceive heat;
- (c) failure to recognize the need to exit spa;
- (d) physical inability to exit spa;
- (e) fetal damage in pregnant women; and
- (f) unconsciousness and danger of drowning.

WARNING: THE USE OF ALCOHOL OR DRUGS CAN GREATLY INCREASE THE RISK OF FATAL HYPERTHERMIA IN HOT TUBS AND SPAS

LA CONSOMMATION D'ALCOOL OU DE DROGUE AUGMENTE CONSIDÉRABLEMENT LES RISQUES D'HYPERTHERMIE MORTELLE DANS UNE CUVE DE RELAXATION.

GLOSSARY OF SPA TERMINOLOGY

Your new Master Spa features a variety of jets. All jets, regardless of style return the water to the spa. Air is mixed with the water by using the air controls (if equipped) creating a gentle to most vigorous massage. Water flow is adjusted by simply turning the outer face of the jet. Your Master Spa may have a combination of pulsating, rotating, dual pulsating and directional adjustable jets.

1. THERAPY JETS

Located throughout the seats of the spa to offer a variety of therapy combinations.

2. NECK JETS (if equipped)

Located above the normal water level to provide massaging action to the back of the neck.

3. SHOULDER JETS (if equipped)

Located above the normal water level to provide massaging action to the shoulders.

4. MASTER BLASTER FOOT THERAPY JET (if equipped)

Large jet with several fixed nozzles located in the bottom of the spa near the floor to provide excellent massage to the feet.

5. JET DIVERTER VALVE (if equipped)

Located on the top flange of the spa, this large valve physically diverts the flow of water from one group of jets to another. Be sure that no sand or particles are brought into the spa as they will cause the diverter to seize up. It is best to turn the diverter valve only when the pump is turned off.

6. WATER FEATURE VALVE (if equipped)

Located on the top flange of the spa, this smaller valve adjusts water flow to the waterfalls and/or water features in your spa.

NOTE: When the spa is not in use, this valve should be turned mostly shut (not completely shut) to prevent the water features from allowing water to hit the cover while it is closed. If left mostly open, water may hit the cover and possibly run out of the spa causing water loss.

7. AIR CONTROL VALVE

These smaller valves are located around the top of your spa. You may increase or decrease the force of your jets by opening or closing the air control valves. Each air control valve will typically function 1 to 2 groups or seats of jets in the spa. When not in use the air controls should be kept in the closed position as the air being introduced in to the water can tend to cool the water and increase the dissipation rate of sanitizer levels.

8. TOPSIDE CONTROL PANEL

You may safely control spa functions from inside or outside your spa using the Topside Control Panel. This Panel is used to control the water temperature, pumps, the spa light, automatic filtration cycles and other advanced functions. The digital display will give you a constant temperature readout and will notify you in case of certain malfunctions. Several user programmable functions are also available.

GLOSSARY OF SPA TERMINOLOGY

9. PERSONAL REMOTE CONTROL (if equipped)

Select spa models may have an additional remote which allows the user to control the jet therapy while remaining in the seat (if applicable). By pressing the control one time, you will activate the pump. Press again for high speed and again to turn it off.

10. EQUIPMENT ACCESS PANEL

This is the skirt panel located below the Topside Control Panel. This area houses the majority of components responsible for the spas operation. These components include the pumps, heater, spa control system, ozonator (if equipped), and LED light system (if equipped). Pump and equipment placement may vary by model.

11. ACCESS PANELS

These are the skirt panels located around all four sides of the spa. All of the skirt panels are removable should service be required. Master Spas recommends at least 3 feet of access be provided around the spa.

12. FILTER LID

This lid fits over the filter area and weir gate to cover the filters. Remove filter lid to access filters for maintenance.

14. WEIR GATE

The weir gate is the horizontal door located in front of the filters that helps keep debris trapped in the filter area

15. SPA CONTROL SYSTEM

This houses the wiring and electrical components necessary to operate the spa.

16. SPA HEATER

This is an electric heater housed in a stainless steel tube. It is thermostatically controlled and equipped with high-limit temperature safety shut-off sensors.

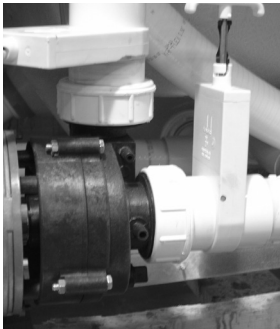

Slice Valve and Pump Union

17. SLICE VALVES

These valves are used by service personnel to shut off water to the heating system (heater and pump plumbed to the heater) so that the spa water does not need to be drained if the spa requires service to the heating system (varies by model).

NOTE: Slice valves must be completely open during normal operations.

GLOSSARY OF SPA TERMINOLOGY

18. MAIN THERAPY PUMP

This produces water flow through the main jets in the spa. The first pump may be operated on two speeds (varies by model). Low speed (if applicable) will produce efficient water circulation during filtration, heating of the spa water, and gentle jet action. High speed provides maximum jet action. The main pump is controlled by the "Jets" or "Jets I" button on the Topside Control Panel.

19. SECONDARY THERAPY PUMP (if equipped)

This produces water flow through 1 to 2 groups or seats of jets in the spa. The second pump operates similar to the main pump and is controlled by the "Jets II" or "Aux" button on the Topside Control Panel.

20. THIRD THERAPY PUMP (if equipped)

This produces water flow through 1 to 2 groups or seats of jets in the spa. This is controlled by the Jets III button on the Topside Control Panel.

21. CIRCULATION PUMP (if equipped)

This produces water flow through the heater in the spa and provides the water flow necessary to actuate the ozone injector. This energy efficient pump typically runs 24 hours for efficient filtration and heating.

22. PUMP UNION

These are used to help relieve possible pump air locks or for service personnel to easily service the pumps.

23. HEATER UNION

These are used by service personnel to easily service the heater.

SITE PREPARATION / GENERAL GUIDELINES

Portable spa installation is simple when properly planned. It is important that you read the following information carefully and consult with your Master Spas dealer.

- 1) Access - The actual dimensions of your new spa will determine the amount of space that is needed in moving the spa from curbside to its final installation area. Be sure to consider and measure side yard dimensions, gates, doors, overall room dimensions and vertical obstructions such as ceilings, roof overhangs, balconies and overhead cables. Any other space limiting obstacles such as stairs, trees, and shrubs must also be evaluated. Please be sure to contact and review these site and installation plans with your Master Spas dealer prior to delivery.
- 2) Surface/Pad Requirements - When your new spa is filled with water and bathers, it may weigh as much as several tons. It is imperative that the base beneath the spa can support the entire weight. The spa must be on a uniformly firm, continuous, and level surface. The recommended foundation is a concrete pad with a minimum thickness of four (4) inches with steel reinforcement bars crossed throughout the pad.

IMPORTANT

When installing your spa indoors, on a wood deck, roof or balcony; load requirements need to be evaluated before installation. You should speak with a qualified contractor or your local building department to confirm that your surface is adequate for supporting a spa.

All sides of the spa must be accessible for regular maintenance or in the event that service is needed. Periodical maintenance checks require entry into the equipment bay. When possible, it is wise planning for the future to leave 3 feet of access to all sides of the spa in the event your spa requires maintenance. Your spa warranty does not cover the cost of providing access for service.

GENERAL CONSIDERATIONS FOR OUTDOOR INSTALLATION

Again, proper planning will increase your total enjoyment factor with your new spa. Listed below are some additional items to consider when planning your installation.

- How spa will complement landscaping and vice versa
- View from inside spa and view of spa from inside of home
- Exposure to sunlight and shading from trees
- Privacy
- Getting to spa from house and return
- Proximity to dressing rooms and bathrooms
- Storage for spa chemicals
- Local building codes (if applicable)
- Power cable

GENERAL CONSIDERATIONS FOR INDOOR INSTALLATION

Installing your spa indoors creates an entirely different set of considerations.

- Work with your Master Spas dealer and contractor to insure all local building, electrical and plumbing codes are met
- Plan for a floor drain to drain off excess water and for draining and cleaning your spa
- A ventilation fan may be necessary due to high humidity created by your spa
- Finished material in your spa room should also be capable of withstanding increased humidity

SITE PREPARATION / GENERAL GUIDELINES

GUIDELINES FOR PARTIALLY OR FULLY RECESSED INSTALLATION

Spas manufactured by Master Spas, Inc. are designed to be installed in a variety of settings. One of which is installing below grade. Should a spa be installed below the level of the site drainage system (below grade), a system for preventing water collecting and pooling must be designed based on the requirements of the local authority having jurisdiction. The drainage system must be designed based on things such as rainfall, water runoff, splashing, draining the spa, etc. that could potentially feed the below grade area with water. Where located in designated floodways, additional attention to maximum water load entering the area below grade must be addressed to prevent water from accumulating below grade at all times. It is generally recommended that the spa be installed above grade because the spa is not designed to be submerged in water. When a proper drainage system is designed based on the characteristics of the site, installing the spa below grade is an accepted method of installation.

- The unit is self-supporting when placed on a surface designed to support the full load of the spa (see Surface/Pad Requirements). Do not backfill with sand, gravel, or earth. Doing so will void the warranty.
- Plan for complete drainage so standing water never reaches the electrical equipment.
- Plan for appropriate ventilation so the equipment doesn't overheat.
- Provide a minimum of 3 feet service area around the perimeter of the unit. Site access issues are not covered by the product warranty.
- The unit is not designed to be submerged in water. Water entering the equipment area creates many hazards and resulting damage will not be covered by the product warranty.
- Make sure that the surroundings do not create any additional hazards.
- Surfaces placed around the unit should also be evaluated for walking/slipping hazards from standing water. Proper drainage is vital to the installation of a below grade installation.
- Check all building, electrical, and plumbing codes with the authority having jurisdiction to ensure that your installation is in compliance with all local codes.
- Additional consideration needs to be made when installing unit in designed floodways.
- Verify that site specific drainage systems such as down spouts are not going to feed the area below grade.
- Below grade drainage system needs to be evaluated based on area specific rainfall. One size does not fit all so an analysis by a qualified, local engineer to ensure proper drainage of all sources of water is a must when installing below grade.

SITE PREPARATION / GENERAL GUIDELINES

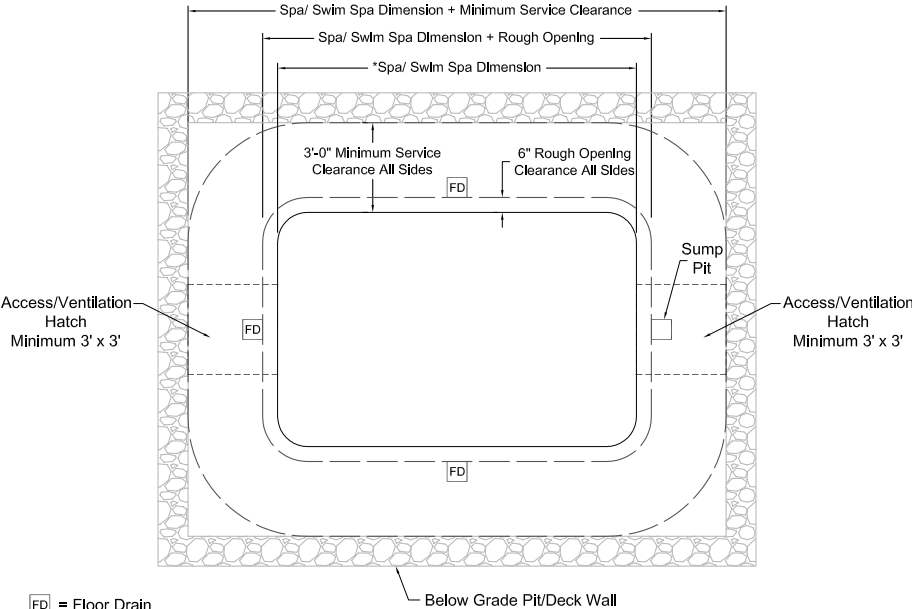

- FD = Floor Drain
- = Access/ Ventilation Hatch (Min. 3' x 3')
- * = See "Model Specification" section of Owner's Manual for applicable Spa/ Swim Spa dimensions.

INSTALLATION INSTRUCTIONS

1. Put spa in final position that allows for access to equipment and spa components. Master Spas recommends that at least 3 feet of space be provided around all sides of the spa for access. This provides adequate space for regular maintenance and service.
2. Remove front skirt panel (this is the side where the topside control panel is located) so electrical can be hooked up to the spa control system. This panel is removed by unscrewing the screws securing the skirt corners and the front skirt panel.
3. With the front skirt panels removed allowing access to the equipment, be sure all pump and heater unions are secure. Each pump has 2 unions and the heater has 2 unions. A newly delivered spa may have loose unions caused in transporting the spa. Check that all slice valves are open, in the up position. The slice valves may become closed during transportation of the spa.

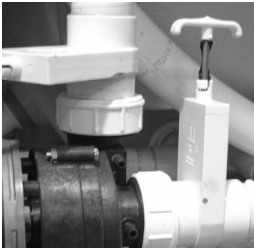

*Slice Valve
and Pump Union*

4. Fill spa at least 1" above the filters or to the minimum water level indication located near the filter area. We recommend filling the spa through the filter area.
5. Turn the power on to the spa. Spa will initially display Priming Mode or "Pr". This lasts approximately 5-6 minutes. This time is provided to allow each of the pumps to be activated and checked to ensure they are not air locked from the spa being filled.
6. Be sure the adjustable jets in your spa are open by turning the face of the jet. Most of the jets in your spa are adjustable and removable by turning the face of the jet.

INSTALLATION INSTRUCTIONS

7. It may be necessary to bleed air from the pump(s) in your spa if, after start up, your spa pumps are turning on and off but you do not have water flow from the jets in your spa. Due to the nature of water flow and hydro-therapy pumps, please be advised that air locking of pumps may occur. Master Spas has taken measures to reduce the possibility of this, but it still may occur, especially after refilling a spa. This is not a service covered under warranty.
- To relieve and airlock, loosen the union on the discharge of the pump (see arrow on picture of pump below). Water should leak out. Tighten the union and test the pump for proper jet flow. If needed repeat process.

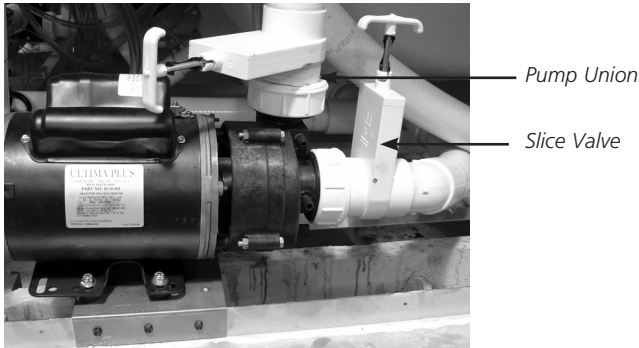

Airlock

8. Adjust water chemistry according to the instructions provided in the "Water Maintenance" section.
9. Your spa water will heat approximately 3 to 4 degrees Fahrenheit per hour (1 to 2 degrees Celsius) with the cover placed on the spa. This varies depending on the size of the spa and ambient temperatures.
10. Step into the soothing waters of your Master Spa!
Relax and enjoy.

THE ADVANTAGES OF ECO PUR™ FILTRATION



Eco Pur™ water filter system is designed to reduce the use of chemicals in your spa. You will still be required, periodically, based on usage to add a small amount of chlorine to oxidize organic compounds in the water. The Eco Pur™ filter system will not eliminate the need to maintain proper water chemistry but can make the maintenance a more natural experience.

FEATURES

- The Eco Pur™ filter system will not oxidize organic compounds and will require periodic doses of chlorine to assist in the sanitization and oxidation processes required to maintain clear spa water.
- Eco Pur™ filter system will not alter the pH of spa water. The Eco Pur™ filter system will actually aid in stabilizing the pH. Eco Pur™ does not alter the (TDS) total dissolved solids.
- The main function of the Eco Pur™ filter system is to provide clean and clear spa water. Proper chemical balance and filtration are also key components in maintaining healthy spa water. Always ensure that the pH and total alkalinity of the spa water is checked and balanced at all times. To ensure proper filtration, clean the regular filter cartridge with a "filter cleaner" every 30 days and rinse the Eco Pur™ cartridge with a hose to remove any buildup of containments. (Do not soak the Eco Pur™ cartridge in filter cleaner.) If water appears to be visually cloudy, dull, or has an odor, shock the spa water with 1 ounce of chlorine* to remove excessive containments. When cleaning filters, be sure to never have the pumps (including the circulation pump) running without the filters in place. Failure to do so may result in debris being drawn into the pumps causing unwarranted damage.
- Helps remove calcium carbonate and hydrogen sulphide from spa water to protect heaters and equipment from precipitation.
- Helps stabilize the pH and alkalinity of the spa water.
- Helps reduce chemical usage and still provide safe odor-free water.
- Helps deplete excess chlorine after chemical shock to prevent damage to skin, hair, and swim wear.
- Helps to produce ultra clean and clear water.

Note: Eco Pur™ filters are not recommended for use with Bromine. Consult your dealer for additional information.

Master Spas, Inc. products are not designed to be used with Biquanides. These chemicals are found in SoftSwim® and Baqua Spa® products. Due to adverse effects from these types of sanitizers, the use of these products may void the spa warranty.

WATER CHEMISTRY TERMS YOU SHOULD KNOW

Before jumping into Water Maintenance, here are some terms to help you.

- 1. Parts per million, or ppm:** This is a form of measurement used in most pool or spa chemical readings. Best described as any one million like items of equal size and make up, next to one unlike item, but of equal size. This would be one part per million.
- 2. Average size spa:** What is it? The national spa and pool institute (NSPI) states; 350 to 400 U.S. gallons is average. As a general rule, chemical dosages are the same for any spa between 100 and 500 U.S. gallons. Spas over 500 U.S. gallons the dosage would be double. Under 100 U.S. gallons would be on a case by case basis.
- 3. Total Alkalinity:** This is a measurement of the ability of the water to resist changes in pH. Put another way, it is the water's ability to maintain proper pH. Total alkalinity is measured in parts per million from 0 to 400 plus, with 100 to 120 ppm being the best range for spas. With low alkalinity, the pH will flip, or change back and forth, and be hard to control. With high alkalinity it becomes extremely difficult to change the pH.
- 4. pH or potential hydrogen:** This is a measurement of the active acidity in the water, or it is the measurement of the concentration of active hydrogen ions in the water. The greater the concentration of active hydrogen ions, the lower the pH. pH is not measured in parts per million, but on a scale from 0 to 14, with 7 being the neutral. The pH in spas should be ideally maintained between 7.4 to 7.6. It should never be below 7.2 or above 7.8. With low pH, the results can be corroded metals, etched and stained plaster stained fiberglass or acrylic, eye / skin irritation, rapid chlorine or bromine loss, and total alkalinity destruction. With high pH, the results can be cloudy water, eye / skin irritation, scale formation and poor chlorine or bromine efficiency.
- 5. Shocking:** This is when you add either extra chlorine (superchlorinate) by raising the chlorine level above 8 ppm, or add a non-chlorine /oxidizer (potassium monopersulfate or potassium monopersulfate) to burn off the chloramines or bromamines. A non-chlorine /oxidizer acts by releasing oxygen in the water, which serves the same function as chlorine. The advantage to using non-chlorine /oxidizer, is you can enter the water within 15 minutes after application. Using chlorine, you must wait until the total chlorine reading is below 5 ppm. One thing to remember, a non-chlorine /oxidizer will not kill bacteria or disinfect.
- 6. Sequestering:** This can be defined as the ability to form a chemical complex which remains in solution, despite the presence of a precipitating agent (i.e. calcium and metals). Common names for sequestering chemicals are; minquest, stain and scale control, metal-x, spa defender, spa metal gone, (etc.).
- 7. Filtration:** Filters are necessary to remove particles of dust, dirt, algae, etc. that are continuously entering the water. If the spa is not operated long enough each day for the filter to do a proper job, this puts a burden on the chemicals, causing extra expense. Filtration time will depend on the spa size, pump and filter size and, of course, bather load. Spare filter cartridges should be kept on hand to make it easy to frequently clean the cartridge without the need for a long shut down. This will also allow the cartridge to dry out between usages, which will increase the cartridge life span as much as twice. Replace the cartridge when the pleats begin to deteriorate. Cartridge cleaning should be done a minimum of once a month. More often with a heavy bather load.

WATER CHEMISTRY TERMS YOU SHOULD KNOW

8. **Sanitizers:** This is what kills the germs and bacteria that enter the water from the environment and the human body.
- A. Chlorine
1. Only one type is approved for spa use. Sodium dichlor which is granular, fast dissolving and pH neutral chlorine.
 2. Chlorine is an immediate sanitizer and will be added as needed to maintain free chlorine levels between 2.0 to 4.0 ppm..
- B. Bromine (Note: Bromine use is not recommended with Eco Pur filters.)
1. Two types of tablets.
 - a. Hydrotech
 - b. Lonza
 2. Bromine is a slow dissolve chemical and may take a few days to develop a reserve or reading in the water. Bromine levels should be maintained between 2.0 to 4.0 ppm.
9. **Total dissolved solids (TDS):** Materials that have been dissolved by the water. i.e. Like what happens when you put sugar in coffee or tea.
10. **Useful life of water (in days):** Water should be drained at least once every 180 days. Useful life may vary by usage and bather load.
11. **Defoamer:** Foaming may be caused by body oils, cosmetics, lotions, surface cleaners, high pH or algeacides as well as other organic materials. Low levels of calcium or sanitizer can also cause foaming. Also, double rinse your bathing suits as they will hold residual soap after being washed.
12. **Calcium hardness:** Water that is too hard (over 250 ppm) can promote scale formation in components and on spa surface. Water that is too low (below 150 ppm) may also shorten the life of metal components on the spa.
- NOTE:** Always leave spa cover open for 15 minutes after adding chemicals to prevent the off gas from damaging your spa cover, spa pillows, stainless steel hardware and other critical parts.

WHY ARE CHEMICALS IMPORTANT IN A SPA

1. **Evaporation:**

As water evaporates, only pure water evaporates, leaving the salts, minerals, metals, and any unused chemicals behind. Adding water adds more salts, minerals, and metals. In time, the water can become saturated with these dissolved solids and can cause stains or scale to form on the walls of the spa or a scale build up inside the equipment. Colored or cloudy water, and possible corrosion of plumbing and fittings may also occur.

2. **Heat:**

Heat causes much quicker evaporation and also will cause minerals and metals to precipitate out of solution.

3. **Air:**

Dust and other airborne contaminants are introduced into the spa.

4. **Environment:**

The environment surrounding the spa can also impact the water quality. Items such as pollen, grass, sand, dirt, lawn fertilizer, airborne dust, insects, leaves, and pets can all affect the water quality of the spa.

5. **Bathers:**

As the spa is used, bathers introduce contaminants to the water. Increased bather load, length of use and frequency will increase the amounts of contaminants added in to the water.

Remember:

The maintenance routines set forth in this manual may need to be adjusted depending on bather load and how much the spa is being used.

WATER MAINTENANCE – START-UP

- Step 1:** Your spa should be filled using a Pre-filter, which can be obtained from your local dealer. This Pre-filter will help remove many of the minerals existing in the water, which will make adjusting the water balance easier after a new fill. Never use more than 50% softened water when filling the spa.
- Step 2:** During the initial filling of the spa, add a sequestering agent to combat suspended minerals in the water. The agents are sold under many different names such as Mineral Clear or Metal Protect. Allow water to circulate and filter for at least 30 minutes (or per bottle recommendations) before adding any other chemicals.
- Step 3:** Test water for pH, total Alkalinity, and Calcium hardness. The pH should be 7.4 - 7.6 and the total Alkalinity 100 - 120 ppm. Calcium hardness levels should be maintained between 150 and 250 ppm (part per million).
- Step 4:** Adjust pH and total Alkalinity (TA) utilizing the directions on the chemical bottles. Wait 15 minutes, test and adjust if necessary.
- Step 5:** It may be necessary to retest and add additional chemicals to get to the proper levels in Step 3.
- Step 6:** Add concentrated chlorinating granules* (sodium Dichlor-s-triazinetreone) to reach a Free Chlorine level of 5 to 8 ppm on initial start up to begin sanitizing the spa water. Bathers should not enter the spa until the chlorine levels drop below 5.0 ppm. Always refer to the chemical manufactures dosage recommendations listed on the container. It is important not to add the chlorinating granules until the pH, alkalinity and calcium hardness have been adjusted to their proper levels.

*SPECIAL NOTE:

We recommend a minimum level of 2.0 ppm residual free chlorine be maintained in spa water. Always refer to the chemical manufacturer's dosage recommendations listed on the container.

When adding chlorine or non-chlorine shock/oxidizer always broadcast across the water while the pumps are running.

The quantities of sanitizer and oxidizer shown in this manual are for 500 gallon spas and may have to be adjusted depending on the actual amount of water that your spa holds. See the specifications section of this manual for the correct gallons of your spa.

The concentration of active ingredients in spa chemicals varies by manufacturer. The amounts of sanitizer suggested in this manual are based on spa chemicals that have the active ingredient percentages listed below:

Chlorine	Non-Chlorine Shock/ Oxidizer
Active ingredient:	Active ingredient:
Sodium dichlor 99%	Potassium peroxymonosulfate 42.8%
Other ingredients..... 1%	Inert ingredients 57.2%
Total..... 100%	Total..... 100%

WATER MAINTENANCE – SCHEDULE

BEFORE EACH USE

Check spa water with a test strip for proper sanitation levels and adjust accordingly to the proper levels. Free chlorine level should be 2.0 - 4.0 ppm. Appropriate levels should be present before use of the spa. Bathers should not enter the spa if total chlorine levels are above 5.0 ppm or if free chlorine levels are below 2.0 ppm.

ONCE A WEEK

Add non-chlorine shock/oxidizer* or chlorine* to spa to help maintain the water quality.

3 TIMES A WEEK

Test water using chemical test strips. Adjust sanitizer, pH and Alkalinity accordingly. The total alkalinity should be between 100 - 120 ppm and the PH should be between 7.4 - 7.6. If free chlorine level measures less than total chlorine level, additional non-chlorine shock/oxidizer* treatment is necessary.

ONCE A MONTH

Soak your regular filter elements overnight in a container with spa Filter Cleaner and then rinse with clean water. For best results, allow the filter to dry before re-inserting. (The Eco Pur™ mineral element should never be cleaned in a filter cleaner. Just rinse with water.) When cleaning filters, be sure to never have the pumps (including the circulation pump) running without the filters in place. Failure to do so may result in debris being drawn into the pumps causing unwarranted damage. See the “clean your filter elements” in the maintenance section of this manual for more information.

EVERY 180 DAYS

Drain and refill your spa with fresh water, install a new Eco Pur™ filter element, clean the regular filter, and repeat start up procedure. The regular filter should be replaced at least once every year.

AFTER EACH USE

Add non-chlorine shock/oxidizer* or chlorine* to the spa water.

*SPECIAL NOTE:

We recommend a minimum level of 2.0 ppm residual free chlorine be maintained in spa water. Always refer to the chemical manufacturer’s dosage recommendations listed on the container.

When adding chlorine or non-chlorine shock/oxidizer always broadcast across the water while the pumps are running.

The quantities of sanitizer and non-chlorine oxidizer shown in this manual are for 500 gallon spas and may have to be adjusted depending on the actual amount of water that your spa holds. See the specifications section of this manual for the correct gallons of your spa.

The concentration of active ingredients in spa chemicals varies by manufacturer. The amounts of sanitizer suggested in this manual are based on spa chemicals that have the active ingredient percentages listed below:

Chlorine	Non-Chlorine Shock/ Oxidizer
Active ingredient:	Active ingredient:
Sodium dichlor..... 99%	Potassium peroxymonosulfate 42.8%
Other ingredients..... 1%	Inert ingredients 57.2%
Total..... 100%	Total..... 100%

WATER MAINTENANCE – SCHEDULE

AS NEEDED

If water looks hazy, check PH and Total Alkalinity, and treat with chlorine*. Always refer to the chemical manufactures dosage recommendations listed on the container. Free chlorine levels should be maintained between 2.0 - 4.0 ppm.

These are general recommendations for water maintenance that may vary by usage and bather load. Depending on bather load and frequency of use, drain and refill times may vary as well as the frequency of cleaning your filters.

A defoamer may be used when excessive foaming occurs. Over use of a defoamer will result in cloudy, milky water.

USE ONLY SPA CHEMICALS

Do not use chemicals designed for use in swimming pools.

With a spa you are working with a small volume of hot water compared to a large volume of relatively cool water in a swimming pool. Because of this chemicals will have a shorted life span and bacteria can grow more quickly than in a swimming pool. A spa is less forgiving then a pool and requires that whatever is put into it have a pH as close to neutral as possible. That is why only chemicals made for spas should be used. Always refer to the chemical manufactures dosage recommendations listed on the container.

*SPECIAL NOTE:

We recommend a minimum level of 2.0 ppm residual free chlorine be maintained in spa water. Always refer to the chemical manufacturer's dosage recommendations listed on the container.

When adding chlorine or non-chlorine shock/oxidizer always broadcast across the water while the pumps are running.

The quantities of sanitizer and oxidizer shown in this manual are for 500 gallon spas and may have to be adjusted depending on the actual amount of water that your spa holds. See the specifications section of this manual for the correct gallons of your spa.

The concentration of active ingredients in spa chemicals varies by manufacturer. The amounts of sanitizer suggested in this manual are based on spa chemicals that have the active ingredient percentages listed below:

Chlorine	Non-Chlorine Shock/ Oxidizer
Active ingredient:	Active ingredient:
Sodium dichlor 99%	Potassium peroxymonosulfate 42.8%
Other ingredients..... 1%	Inert ingredients 57.2%
Total..... 100%	Total..... 100%

WATER MAINTENANCE – TROUBLE-SHOOTING GUIDE

PROBLEM	POSSIBLE CAUSES	HOW TO FIX IT
Chlorine / Bromine Odor	• Excessive Chlorine or bromine levels	• Shock water with non-chlorine shock treatment
	• Low pH	• Adjust pH if necessary
Water Odor	• Low levels of sanitizer	• Shock water with non-chlorine shock treatment or adjust sanitizer levels
	• pH out of range	• Adjust pH level if necessary
	• Bacteria or algae growth	• Adjust sanitizer if necessary
Cloudy Water	• Dirty filters or inadequate filtration	• Clean filters and adjust filtration times
	• Water chemistry not balanced	• Adjust chemistry levels
	• Suspended particles or organic materials	• Add spa clarifier (see dealer)
	• Old water	• Change spa water
Scum Ring Around Spa	• Build up of oils, dirt and organic elements	• Wipe off with a clean towel add an enzyme product.
Eye / Skin Irritation	• Unsanitary water	• Shock spa with non-chlorine shock
	• Free chlorine level above 5 ppm	• Allow level to drop below 5 ppm
	• Poor sanitizer / pH levels	• Adjust according to spa test strip results
Foaming	• High levels of body oils, lotions, soap, etc.	• Add small amount of defoamer
Deep Blue Water Color or Colorful Deposits Precipitating from Water	<ul style="list-style-type: none"> • Excessive build up in the water from total dissolved solids, bather load and chemical treatments over time • Reaction between substances in water and types or excessive amounts of chemicals added to water 	• Draining and fresh fill of water may be required

*RECOMMENDED LEVELS OF CHEMICAL

Free Chlorine 2.0 - 4.0 ppm

pH 7.4 - 7.6

Total Alkalinity 100 - 120 ppm

Calcium Hardness 150 - 250 ppm

*Recommended levels stated in this manual are based on industry standards for permanently installed and portable residential spas and swim spas.

REGULAR MAINTENANCE PROCEDURES

Note: These are areas that will require the spa owner to perform routine maintenance. These are not areas covered under the warranty of the spa.

Your spa requires periodic draining and cleaning to ensure a safe, healthy environment. It is recommended that you clean your spa at least every 180 days or as necessary. Heavy bather load will require cleaning it more often.

DRAINING YOUR SPA

- The spas are equipped with a drain assembly which can be located on the front side of the spa behind the skirt (same side as the topside control panel or where most of the spa equipment is located). Location varies by model. The drain will either be mounted to the front, right corner at the base of the frame (Figure 1) or will be located in the equipment area behind the front skirt panel (Figure 2).



Figure 1

Figure 1: Access to the drain can be gained by removing the panel screws or thumb screws from the front, right corner panel. The drain should be mounted at the base of the corner as shown in Figure 1. If your model does not have a drain located in the base of the corner, proceed to the steps for Figure 2.

Grasp the drain cap, and pull the assembly out as far as it will go. Unscrew the cap from the assembly. Push the drain back in midway to start the flow of water. A garden hose can be attached to the end of the drain assembly, if so desired.

Figure 2: Access to the drain can be gained by removing both front corner skirt panels. To do so, remove the screws or thumbscrews from the corner panels. Next, remove the front skirt panel by removing its panel screws. The drain will be located inside the equipment bay (see Figure 2 & Figure 2.1). To start the flow of water with this drain assembly; remove the cap, twist the face counterclockwise and pull out slightly on the face. A garden hose can be attached to the end of the drain assembly, if so desired.

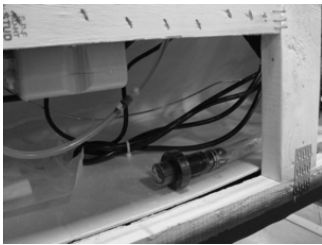

Figure 2



Figure 2.1

NOTE:

- With the cap removed from the drain; water may drip or weep from the drain. This is normal. Be sure that the steps are followed in reverse order when draining is finished. Make sure that the drain cap is reattached and the valve is put back to the fully closed position so that there is no water leaking from the drain assembly.
- Draining times will vary by model using the drain assembly. A sump pump may also be used to expedite the draining of the spa.

REGULAR MAINTENANCE PROCEDURES

Note: These are areas that will require the spa owner to perform routine maintenance. These are not areas covered under the warranty of the spa.

CLEAN YOUR SPA SURFACE

- With a soft cloth, wipe down the spa surface with a non-abrasive spa surface cleaner that may be purchased through your local spa dealer. Do not use paper towels. Be sure to rinse residue from spa surface.
- If your spa has developed an oily or chalky residue at the waterline it may require special treatment. Consult your dealer.

CLEAN YOUR FILTER ELEMENTS

The filter elements are one of the most important components of your spa. Not only are they essential for clean water, but they also extend the life of the spa equipment. Your filter elements should be cleaned on a regular basis, once a month on average with normal usage. With heavy use the filters may need to be cleaned more often.

- Turn off the spa before servicing filters. Never leave the spa running when removing the filters. Debris can be pulled into the plumbing system and cause unwarranted damage.
- Remove filter element(s).
- With a garden hose, spray each element under pressure. Periodically, the standard filter elements need to be soaked in a filter cleaner compound. Do not soak Eco Pur mineral filters in a filter cleaner. Eco Pur filters should only be rinsed with fresh, clean water as necessary. Check with your dealer for details on cleaning and/or filter replacement recommendations.
- The Eco Pur Mineral filter should be replaced every 6 months. The standard filter should be cleaned regularly and will typically last approximately 1 year. Bather load, usage and water quality will effect the longevity of the filters and require more frequent cleaning or replacement.

CARE OF YOUR SPA PILLOWS

- Your spa pillows need to be rinsed periodically to remove any chemical residue. This should help to eliminate pillows becoming stiff and discolored.
- If spa is not to be used for a period of time, pillows should be removed. Pillow life will be extended.

NOTE: Do not cover the spa for 15 minutes after adding chemicals as the off gas can cause unwarranted damage.

REGULAR MAINTENANCE PROCEDURES

Note: These are areas that will require the spa owner to perform routine maintenance. These are not areas covered under the warranty of the spa.

CLEANING JETS

The majority of jets in your spa can individually be turned on/off. If any of these jets become hard to turn, it will be necessary to remove the jet to clean it as grit/sand and mineral deposit may be present.

The jets in your spa can be removed for cleaning by unscrewing them (counter clockwise) and then pulling out the jet.



To Clean Jets

Place the jet(s) in a container, fully immerse in white vinegar. Let the jet(s) soak overnight and then rinse with water. Reinstall the jet(s). It may be necessary to clean grit and deposits from the white jet body (mounted in the spa shell) by using a small bristled brush.

CLEANING DIVERTER VALVES

Due to mineral deposits and grit/sand that may get into the internal parts of the diverter valve, it may become hard to turn or freeze up completely. Excessive force applied to turn the valves can cause unwarranted damage to the valve. In this case, it is necessary to remove the handle and cap of the diverter valve. Before proceeding, make sure the power to the spa is turned off.

Turn the cap piece counter clockwise. It may be necessary to put a clean cloth over the cap and turn it with a wrench.

Once loose, the cap and handle can be pulled up out of the white plumbing fitting.

Wipe down the internal piece that attaches to the cap and handle.

Soak the cap and handle in white vinegar.

The white plumbing fitting should also be wiped down. If the surface of the white plumbing has become too abrasive, you can take wet, fine sandpaper and smooth it out. It is also helpful to use a lubricant (use silicone based, not petroleum based) to allow for an easier turn of the diverter handle.

Rinse the diverter internals and reassemble.

In the future, it is helpful to turn the diverter valve only when the pump is not on. Cleaning your diverter valve should occur every time you drain your spa.

REGULAR MAINTENANCE PROCEDURES

Note: These are areas that will require the spa owner to perform routine maintenance. These are not areas covered under the warranty of the spa.

CARE OF YOUR SPA COVER

Always cover your spa when not in use. This will greatly reduce energy consumption and will cause spa water to heat more rapidly. Water loss and chemical usage will also be reduced.

- Be sure to lock down all straps on cover after each use to prevent wind damage.
- Do not allow spa to sit uncovered in direct sunlight. This may cause damage to exposed surfaces and components of the spa and possible discoloration of spa fittings.
- Periodically hose off both sides of spa cover for maximum life of cover. Once a month use a vinyl cleaner and conditioner on the vinyl portion of your cover. Rinse residue off.
- Keep cover open for 15 minutes after adding chemicals to prevent off gas damage.

NOTE: if your spa is going to be left empty for prolonged periods, do not replace cover directly on surface of spa. Place 2"-3" blocks between cover and spa. This allows for adequate ventilation of cover and spa.

NOTE: The cover warranty is not part of the limited warranty provided with the spa. It is provided through the cover manufacturer and may not be through Master Spas. Check the tags and labeling on your cover to verify manufacturer and refer to the manufacturer's care, maintenance and warranty information. Your dealer can help provide you with these details.

NOTE: To prevent premature failure of your spa cover, always turn water feature valve down so that the water features do not hit the cover when the cover is closed.

CARE OF YOUR SPA CABINET

Your skirt is maintenance free. No conditioning is necessary. Simply rinse off the waterproof / U.V. resistant material periodically with fresh, clean water.

CARE OF YOUR OZONE SYSTEM

The ozone hose and check valve connecting between the ozone generator and ozone injector should be inspected and/or replaced, if necessary, every 12 months. Depending on conditions of the air which is being brought in to the ozone generator, the ozone hose and check valve can wear more rapidly. This regular maintenance is not covered under the spa warranty. Your Master Spas Dealer or Service Center can be contacted to schedule this maintenance.

REGULAR MAINTENANCE PROCEDURES

Note: These are areas that will require the spa owner to perform routine maintenance. These are not areas covered under the warranty of the spa.

STAINLESS STEEL

Master Spas uses stainless steel in a number of our spas. Its lasting beauty and resistance to corrosion make it an excellent material for handrails and jets faces.

With the proper care it will keep its luster for many years. All stainless steel can corrode given the right circumstances so we have provided a guide to help you keep the stainless components in your spa looking nice.

Stainless steel derives its ability to resist corrosion by forming a very thin transparent coating on the surface when exposed to oxygen. This coating can be damaged by abrasive materials such as steel wool, sand paper, and other cleaning materials that are abrasive. Chlorine salts, sulfides, or other rusting metals can also erode this thin coating exposing the metal to corrosion.

The best defense to combat corrosion on stainless steel components in your spa is make sure that it is kept clean and free of any chemical build up.

Always:

- Clean frequently with clear, clean, non-chlorinated water.
- Remove any rust spots as soon as they appear with vinegar or a brass, silver, or chrome cleaner.
- Use a good car cleaning wax for extra protection.
- Leave cover removed for at least 15 minutes after adding chemicals to the spa water.

Never:

- Clean with mineral acids or bleaches.
- Clean with steel wool or any other abrasive material.
- Leave in contact with iron, steel any other metals.
- Close the cover immediately after adding chemicals to the water.

NOTE: Failure to take proper care of the stainless steel fould result with them rusting. Rusting is not covered by the warranty.

NOTE: Do not cover the spa for 15 minutes after adding chemicals as the off gas can cause unwarranted damage. Larger dosages can require longer lengths of time to off gas. It is recommended to check spa water more frequently to allow small dosages be added as necessary versus large dosages being added less often.

SPA TROUBLE SHOOTING GUIDE

Note: For wiring outside of U.S. and Canada, GFCI may be referred to as a RCD (residual current device). Be sure all local electrical codes are followed.

NOTHING ON THE SPA OPERATES

1. Check the control panel display for any messages. If there is a message, refer to the diagnostic section on that model spa. There you will find the meaning of the message and what action is to be taken.
2. If there is no message on your control panel, check and reset the GFCI and house breaker.

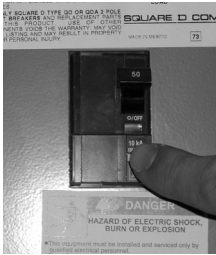

The GFCI should be located in a weather proof box close to the spa, but no closer than 5 ft.

If the spa does not respond, contact your local service company.

PUMP(S) DO NOT OPERATE -

1. Press the “Jets” button on your control panel.

If you hear the pumps trying to operate:

- A. Check that all the slice valves are open.
- B. Pump may need to be primed.
- C. Check that all jets are in their full open positions.

If you do not hear anything from the pump, contact your local dealer or service company.

POOR JET PERFORMANCE

1. Make sure pump is operating
2. Check that the water level is adequate (up to minimum safe water level)
3. Make sure the jets are open and the air controls are open.

SPA TROUBLE SHOOTING GUIDE

Note: For wiring outside of U.S. and Canada, GFCI may be referred to as a RCD (residual current device). Be sure all local electrical codes are followed.

SPA NOT HEATING

If the spas heater has failed, the majority of the time it will trip the GFCI breaker. If the spa is not heating and has not tripped the breaker, please follow these steps:

1. Check the topside control panel for diagnostic messages. Refer to your spa models diagnostic message area. Follow steps to alleviate message.
2. Check water set temperature at topside control panel.
3. Check for dirty filters. Clean or replace if necessary.
4. Check "heat mode" the spa is set in. Spa should be in standard/ready mode.
5. Check the control panel for heater indicator, see controls section of manual. If the indicator is on, the spa should be heating. With the cover closed on the spa, wait a reasonable amount of time (approximately 1 to 2 hours) to see if the water temperature is increasing.
6. Check to make sure that the pump is primed and all slice valves are open.
7. Reset power to the spa at GFCI breaker.
8. If spa is still not heating, contact your dealer for service.

GFCI IS TRIPPING

A ground fault circuit interrupter (GFCI) is required by the National Electrical Code for your protection. The tripping of the GFCI may be caused by a component on the spa or by an electrical problem. Electrical problems include but are not limited to, a faulty GFCI breaker, spa component, power fluctuations, or improper wiring. If this is a new electrical service and GFCI installation, an instantly tripping GFCI may likely be caused by improper wiring of the load neutral from the GFCI to the spa. It may be necessary to contact an electrician if your dealer recommends doing so.



WINTERIZING & STORING YOUR SPA

Winterizing Your Spa

Many people find they enjoy using their spa more in the winter than any other time. Your spa is designed to be used year round in any type of climate.

*However, if you decide you don't want to use your spa in the winter, you must drain it and follow the winterizing steps listed below:

1. Drain your spa completely using the drain valve (if so equipped) or use an inexpensive submersible pump that you can buy from your dealer or your local hardware store.
2. Use a shop vac to get all standing water out of your unit.
3. Remove access panels from equipment area.
4. Loosen and disconnect all pump unions and heater unions.
5. Remove winterizing plug from face of the pump(s) where applicable.
6. Using your shop vac in a blowing mode, insert the hose into the nozzle of each jet and blow the trapped water from the lines into the interior of the spa. A non-toxic, RV water line type antifreeze can be used and added to jets in each seat around your spa to help prevent freeze damage from occurring. Be sure to thoroughly flush the system before startup.
7. After this is completed, use the shop vac to remove any standing water in the spa and in the equipment area.
8. Clean the spa with a soft cloth and a non-abrasive spa surface cleaner.
9. Replace access panels.
10. Cover spa to prevent water from entering the spa.

****Disclaimer: Master Spas does not recommend winterizing your spa. If you choose to do so, any damage that may result is not covered under the spa warranty.***

Storing Your Spa

The spa shell should never be left unprotected and uninsulated while being stored. Clear plastic wrap or similar material should never be used to cover/protect the spa.

Prolonged, direct sun heat can damage the surfaces of the spa along with any components on the spas surface. Always keep the spa covered and protected with an insulating spa cover. Resulting damage such as cracking in the shell surface or warped or discolored components on the spa shell would not be warranted.

An empty spa should never be exposed to temperatures below 0°F (-18°C) after delivery as extreme cold can cause shell damage. This includes storage and draining (winterizing). If your spa can be exposed to these temperatures, keep the unit filled and running. If you do not plan to use your spa, you can set the spa to the lowest temperature setting allowed by the control system.

Failure to adhere to these guidelines will void the warranty.

SPA CARE AND MAINTENANCE RECORD

DATE DATE DATE DATE DATE DATE DATE DATE

Drain & Clean Spa								
Clean Filter Cartridge								
Soak Filter Cartridge in Solution								
Test GFCI								
Clean and Condition Spa Cover								
Miscellaneous Service								
Miscellaneous Service								

SPA CARE AND MAINTENANCE RECORD

DATE DATE DATE DATE DATE DATE DATE DATE

Drain & Clean Spa								
Clean Filter Cartridge								
Soak Filter Cartridge in Solution								
Test GFCI								
Clean and Condition Spa Cover								
Miscellaneous Service								
Miscellaneous Service								

SPA CARE AND MAINTENANCE RECORD

DATE DATE DATE DATE DATE DATE DATE DATE

Drain & Clean Spa								
Clean Filter Cartridge								
Soak Filter Cartridge in Solution								
Test GFCI								
Clean and Condition Spa Cover								
Miscellaneous Service								
Miscellaneous Service								

ELECTRICAL REQUIREMENTS

CONFIGURATION 1 - 120V, 15A SERVICE

Note: Electrical requirements by model is shown in Model Specifications. Only electrical configurations pertaining to the models referenced in this manual are shown.

ELECTRICAL REQUIREMENTS

HAVE YOUR ELECTRICIAN READ THE FOLLOWING INFORMATION BEFORE INSTALLATION BEGINS

Electrical connections made improperly, or the use of wire gauge sizes for incurring power which are too small, may continually blow fuses in the electrical equipment box, may damage the internal electrical controls and components, may be unsafe and in any case will void your warranty.

It is the responsibility of the spa owner to ensure that electrical connections are made by a qualified electrician in accordance with the National Electrical Code and any local and state electrical codes in force at the time of installation.

These connections must be made in accordance with the wiring diagrams found inside the control box. This equipment has been designed to operate on 60Hz, alternating current only, 120 volts are required. Make sure that power is not applied while performing any electrical installation. A copper bonding lug has been provided on the electrical equipment pack to allow connection to local ground points. The ground wire must be at least 14 AWG copper wire (unless local or state codes require a heavier gauge wire) and must be connected securely to a grounded metal structure such as a cold water pipe. All equipment packs are wired for 120 VAC only. The only electrical supply for your spa must include a 15 AMP switch or circuit breaker to open all nongrounded supply conductors to comply with section 422-20 of the National Electrical Code. The disconnect must be readily accessible to the spa occupants, but installed at least five feet from the spa. A Ground-Fault Circuit Interrupter (GFCI), (provided with the spa), must be used to comply with section 680-42 of the National Electrical Code. A ground fault is a current leak from any one of the supply conductors to ground. A GFCI is designed to automatically shut off power to a piece of equipment when a ground fault is detected.

Service to the spa must be dedicated 120V, 15A 2 wire plus ground (14 AWG copper).

Route supplied cord or service into the equipment area for final hook-up to terminals inside the spa control system. The spa must be hooked up to a “dedicated” 120 volt, 15 amp. The term “dedicated” means the electrical circuit for the spa is not being used for any other electrical items (patio lights, appliances, garage circuits, etc.). If the spa is connected to a nondedicated circuit, overloading will result in “nuisance tripping” which requires resetting of the breaker switch at the house electrical panel.

201412

Permanently Connected Equipment Assembly with Pump(s), Heaters, Luminaine, Ozone, Spa Side Control(s), Pump shut off device, and Audio/Video Components.

Note: Some of the above components may be optional or not available with every spa model.

ELECTRICAL REQUIREMENTS

CONFIGURATION 1 - 120V, 15A SERVICE

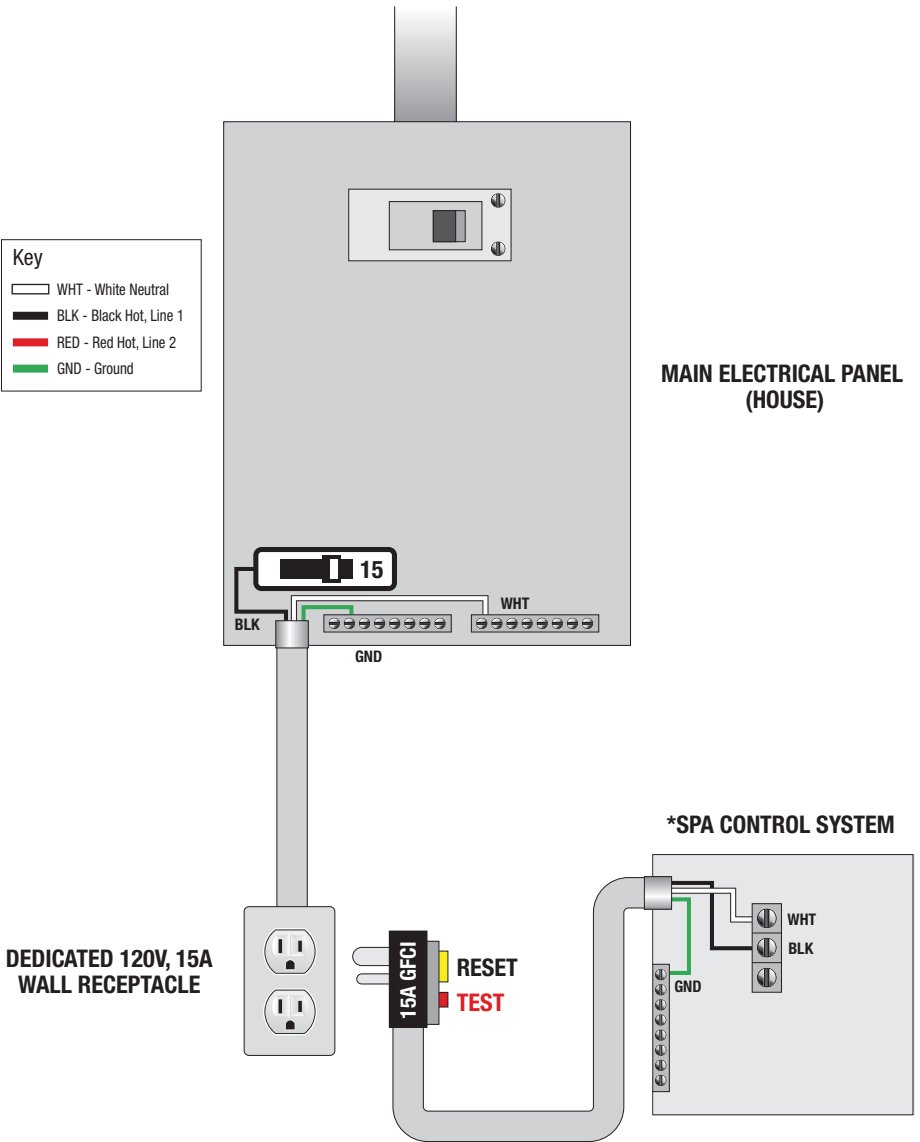

CONFIGURATION 1 120V, 15A SERVICE (DEDICATED)

* Refer to wiring diagram inside spa control system for proper power connection to terminals. Only black hot (L1), white neutral (N) and ground will be connected to the spa control system terminals for this 120V configuration.

ELECTRICAL REQUIREMENTS

CONFIGURATION 2 - 240V, 50A GFCI

Note: Electrical requirements by model is shown in Model Specifications. Only electrical configurations pertaining to the models referenced in this manual are shown.

ELECTRICAL REQUIREMENTS

HAVE YOUR ELECTRICIAN READ THE FOLLOWING INFORMATION BEFORE INSTALLATION BEGINS

Electrical connections made improperly, or the use of wire gauge sizes for incurring power which are too small, may continually blow fuses in the electrical equipment box, may damage the internal electrical controls and components, may be unsafe and in any case will void your warranty.

It is the responsibility of the spa owner to ensure that electrical connections are made by a qualified electrician in accordance with the National Electrical Code and any local and state electrical codes in force at the time of installation.

These connections must be made in accordance with the wiring diagrams found inside the control box. This equipment has been designed to operate on 60Hz, alternating current only, 240 volts are required. Make sure that power is not applied while performing any electrical installation. A copper bonding lug has been provided on the electrical equipment pack to allow connection to local ground points. The ground wire must be at least 8 AWG copper wire and must be connected securely to a grounded metal structure such as a cold water pipe. All Master Spas equipment packs are wired for 240 VAC only. The electrical service for your spa must include a 50 AMP switch or circuit breaker to open all non-grounded supply conductors to comply with section 422-20 of the National Electrical Code. The disconnect must be readily accessible to the spa occupants, but installed at least five feet from the spa. A Ground-Fault Circuit Interrupter (GFCI) must be used to comply with section 680-42 of the National Electrical Code. A ground fault is a current leak from any one of the supply conductors to ground. A GFCI is designed to automatically shut off power to a piece of equipment when a ground fault is detected.

Service to the spa must be dedicated 240V, 50A 3 wire plus ground (#6 AWG copper with minimum #8 AWG copper ground).

Route service into the equipment area for final hook-up to terminals inside the spa control system. The spa must be hooked up to a “dedicated” 240 volt, 50 amp breaker and GFCI. The term “dedicated” means the electrical circuit for the spa is not being used for any other electrical items (patio lights, appliances, garage circuits, etc.). If the spa is connected to a non-dedicated circuit, overloading will result in “nuisance tripping” which requires resetting of the breaker switch at the house electrical panel.

201412

Permanently Connected Equipment Assembly with Pump(s), Heaters, Luminaine, Ozone, Spa Side Control(s), Pump shut off device, and Audio/Video Components.

Note: Some of the above components may be optional or not available with every spa model.

ELECTRICAL REQUIREMENTS

CONFIGURATION 2 - 240V, 50A GFCI

Key

- WHT - White Neutral
- BLK - Black Hot, Line 1
- RED - Red Hot, Line 2
- GND - Ground

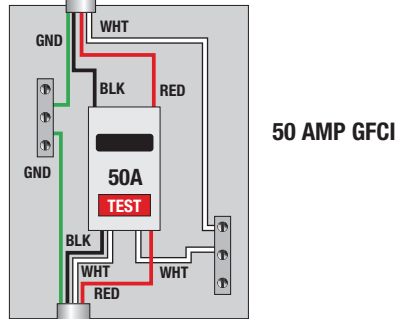
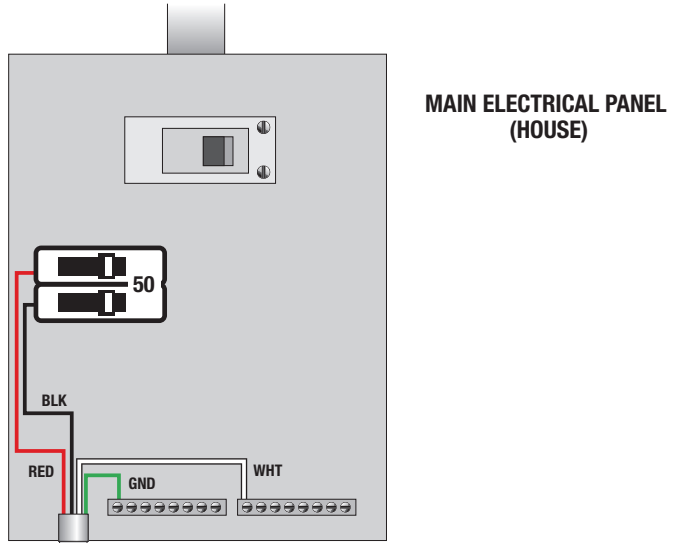

CONFIGURATION 2 240V, 50A GFCI

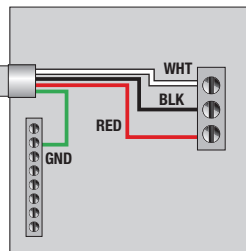

*Refer to wiring diagram inside spa control system for proper power connection to terminals.

MODEL SPECIFICATIONS

Model	Listing Number	Spa Dimensions	Electrical Requirements	Seating Capacity	Water Capacity (gallons)	² Dry Weight (lbs.)	^{2&3} Full Weight (lbs.)	Therapy Pumps
LW 524	1670	66" x 84" x 32"	Configuration # 2 240V, 50A GFCI	3	215	640	2,990	1
LW 715	1680	52" x 86" x 29"	Configuration # 1 120V, 15A SVC	2	135	465	1,965	1
LW 730L	1690	84" x 84" x 36"	Configuration # 2 240V, 50A GFCI	6	325	740	4,560	1
LW ENTERPRISE	3500	84" x 84" x 36"	Configuration # 2 240V, 50A GFCI	6	330	805	4,670	2
LW ENTERPRISE SE	9900	84" x 84" x 36"	Configuration # 2 240V, 50A GFCI	6	330	825	4,690	2
LW INSPIRE	3600	84" x 84" x 36"	Configuration # 2 240V, 50A GFCI	6	325	800	4,625	2
LW INSPIRE SE	9800	84" x 84" x 36"	Configuration # 2 240V, 50A GFCI	6	325	865	4,690	2
LW INTREPID	3400	94" x 94" x 36"	Configuration # 2 240V, 50A GFCI	7	410	945	5,660	2

¹ See Electrical Requirements Section.

² Manufacturing tolerances along with other factors can result in variance in actual spa weight. If weight is a critical figure necessary for delivery, or final installation, we suggest a minimum of 15% be added to the listed weight when planning delivery or installation.

³ Full weight based on dry weight of spa, max seating capacity of spa, assumed average weight per person of 185 pounds and estimated water weight of 8.34 pounds per gallon. Rounded up in increments of 5.

SPA CONTROLS - 120V MODELS

Initial Start-up

When your spa is first actuated, it will go into Priming mode, indicated by “Pr ” The Priming mode will last for less than 5 minutes (press “warm” or “cool” to skip Priming Mode) and then the spa will begin to heat the spa and maintain the water temperature in the Standard mode.

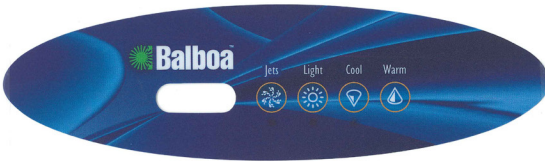

Temp (80°F - 104°F / 26°C - 40°C)

The start-up temperature is set at 100F°/37°C. The last measured temperature is constantly displayed on the LCD.

Note that the last measured spa temperature displayed is current only when the low speed of pump 1 has been running for at least 2 minutes.

To display the set temperature, press the “warm” or “cool” pad.

Temperature setting is accomplished by pressing “warm” to increase the temperature or “cool” to decrease the temperature.

After three seconds, the LCD will stop flashing and display the current spa temperature.

Jets

Touch the “Jets” button once to turn pump 1 on or off, and to shift between low and high speeds. If left running, the pump will turn off after a time-out period.

Light (if equipped)

Press the “Light” button to turn the light on and off. If left on, the light automatically turns off after 4 hours.

L.E.D. Light (if installed)

Press the “Light” button to turn the light on and off. If you wish to change the “function” of the lights, turn the lights off, then on within 5 seconds.

SPA CONTROLS - 120V MODELS

Mode

Mode is changed by pressing the “warm” or “cool” button, then pressing the “light” button.

Standard mode is programmed to maintain the desired temperature. Note that the last measured spa temperature displayed is current only when the low speed of pump 1 has been running for at least 2 minutes. “St” will be displayed momentarily when you switch into Standard Mode.

Economy mode heats the spa to the set temperature only during filter cycles. “Ec” will display solid when temperature is not current, and will alternate with temperature when temperature is current.

Sleep mode heats the spa to within 20°F/10°C of the set temperature only during filter cycles. “SL” will display solid when temperature is not current, and will alternate with temperature when temperature is current.

Preset Filter Cycles

The first filter cycle begins 6 minutes after the spa is energized. The second filter cycle begins 12 hours later. Filter duration is programmable for 2, 4, 6, 8 hours or for continuous filtration (indicated by “FC ”). The default filter time is 2 hours.

To program, press “warm” or “cool” then “Jets.” Press “warm” or “cool” to adjust. Press “Jets” to exit programming. At the beginning of each filter cycle the pump(s) purge for 30 seconds; the pump purges for 5 minutes. The only effect filter duration has is: 1) During the filter, the low-speed of pump 1 never turns off, and 2) In Economy and Sleep Modes, heating only occurs during the filter cycle.

Freeze Protection

If the temperature sensors detect a drop to below 44°F/6.7°C within the heater, the pump will automatically activate to provide freeze protection. The equipment stays on until 4 minutes after the sensors detect that the spa temperature has risen to 45°F/7.2°C or higher. During freeze protection the heater will not be activated.

SPA CONTROLS - 120V MODELS

SPA DIAGNOSTIC MESSAGES

MESSAGE	MEANING	ACTION REQUIRED
	No message on display. Power has been cut off to the spa.	The control panel will be disabled until power returns. Spa settings will be preserved until next power up.
--	Temperature unknown.	After the pump has been running for 2 minutes, the temperature will be displayed.
HH	"Overheat" - The spa has shut down. One of the sensors has detected 118°F/48°C at the heater.	DO NOT ENTER THE WATER. Remove the spa cover and allow water to cool. Once the heater has cooled, reset by pushing any button. If spa does not reset, shut off the power to the spa and call your dealer or service organization.
OH	"Overheat" - The spa has shut down. One of the sensors has detected that the spa water is 110°F/43°C.	DO NOT ENTER THE WATER. Remove the spa cover and allow water to cool. At 107°F/42°C, the spa should automatically reset. If spa does not reset, shut off the power to the spa and call your dealer or service organization.
IC	"Ice" - Potential freeze condition detected.	No action required. The pump(s) will automatically activate regardless of spa status.
SA	Spa is shut down. The sensor that is plugged into the Sensor "A" jack is not working.	If the problem persists, contact your dealer or service organization. (May appear temporarily in an overheat situation and disappear when the heater cools.)
Sb	Spa is shut down. The sensor that is plugged into the Sensor "B" jack is not working.	If the problem persists, contact your dealer or service organization. (May appear temporarily in an overheat situation and disappear when the heater cools.)

SPA CONTROLS - 120V MODELS

SPA DIAGNOSTIC MESSAGES

MESSAGE	MEANING	ACTION REQUIRED
<i>Sn</i>	Sensors are out of balance. If alternating with spa temperature, it may just be a temporary condition. If flashing by itself, spa is shut down.	If the problem persists, contact your dealer or service organization.
<i>HL</i>	A significant difference between temperature sensors has been detected. This could indicate a flow problem.	Check filters for possible blockage. Try cleaning or replacing filters. Check water level in spa. Refill if necessary. If the water level is okay, make sure the pumps have been primed. Check and make sure all jets in spa are in their full open position. If problem persists, contact your dealer or service organization.
<i>LF</i>	Persistent low flow problems. (Displays on the fifth occurrence of " <i>HL</i> " message within 24 hours.) Heater is shut down, but other spa functions continue to run normally.	Follow action required for " <i>HL</i> " message. Heating capability of the spa will not reset automatically; you may press any button to reset. Check filters for possible blockage.
<i>dr</i>	Possible inadequate water, poor flow, or air bubbles in detected in the heater. Spa is shut down for 15 minutes.	Check filters for possible blockage. Try cleaning or replacing filters. Check water level in spa. Refill if necessary. If water level is okay, make sure the pump(s) have been primed. Check and make sure all jets in spa are in their full open position. Press any button to reset, or this message will automatically reset within 15 minutes. If problem persists, contact your dealer or service organization.
<i>dy</i>	Inadequate water detected in heater. (Displays on third occurrence of " <i>dr</i> " message.) Spa is shut down.	Follow action required for " <i>dr</i> " message. Spa will not automatically reset. Press any button to reset.

Warning! Shock Hazard! No User Serviceable Parts. Do not attempt service of this control system. Contact your dealer or service organization for assistance. Follow all owner's manual power connection instructions. Installation must be performed by a licensed electrician and all grounding connections must be properly installed.

SPA CONTROLS

MAIN MENUS



NAVIGATION

Navigating the entire menu structure is done with 2 or 3 buttons on the control panel.

Some panels have separate **WARM** (Up) and **COOL** (Down) buttons, while others have a single Temperature button. In the navigation diagrams Temperature buttons are indicated by a single button icon.

Panels that have two **Temperature** buttons (Warm and Cool) can use both of them to simplify navigation and programming where a single Temperature icon is shown.

The **LIGHT** Button is also used to choose the various menus and navigate each section.

Typical use of the Temperature button(s) allows changing the Set Temperature while the numbers are flashing in the LCD. Pressing the **LIGHT** button while the numbers are flashing will enter the menus.

The menus can be exited with certain button presses. Simply waiting for several seconds will return the panel operation to normal.

Power-up Screens

Each time the System powers up, a series of numbers is displayed. After the startup sequence of numbers, the system will enter Priming Mode

Key

- Indicates Flashing or Changing Segment
- Indicates Alternating or Progressive Message - every 1/2 second
- A temperature button, used for "Action"

Waiting time that keeps the last change to a menu item.

***** Waiting time (depends on menu item) that reverts to original setting and ignores any change to that menu item.

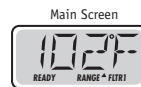
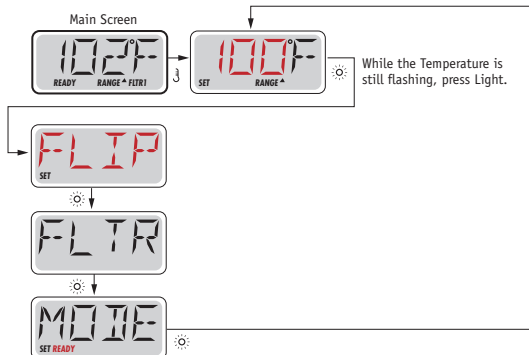

Waiting Several Seconds in the Main Menu will allow the display to revert to the Main Screen. Most changes are not saved unless Light is pressed. Refer to Key above.

SPA CONTROLS

INITIAL START-UP

PREPARATION AND FILLING

Fill the spa to its correct operating level. Be sure to open all valves and jets in the plumbing system before filling to allow as much air as possible to escape from the plumbing and the control system during the filling process.

After turning the power on at the main power panel, the top-side panel display will go through specific sequences. These sequences are normal and display a variety of information regarding the configuration of the hot tub control.

PRIMING MODE

This mode will last for 4-5 minutes or you can manually exit the priming mode after the pump(s) have primed.



Regardless of whether the priming mode ends automatically or you manually exit the priming mode, the system will automatically return to normal heating and filtering at the end of the priming mode. During the priming mode, the heater is disabled to allow the priming process to be completed without the possibility of energizing the heater under low-flow or no-flow conditions. Nothing comes on automatically, but the pump(s) can be energized by pushing the "Jet" buttons. If the spa has a 24 hour Circ Pump, it can be activated by pressing the "Light" button during Priming Mode.

PRIMING THE PUMPS

As soon as the above display appears on the panel, push the "Jet" button once to start Pump 1 in low-speed and then again to switch to high-speed. Also, push the Pump 2 or "Aux" button, if you have a 2nd pump, to turn it on. The pumps will now be running in high-speed to facilitate priming. If the pumps have not primed after 2 minutes, and water is not flowing from the jets in the spa, do not allow the pumps to continue to run. Turn off the pumps and repeat the process. Note: Turning the power off and back on again will initiate a new pump priming session. Sometimes momentarily turning the pump off and on will help it to prime. Do not do this more than 5 times. If the pump(s) will not prime, shut off the power to the spa and follow the instructions shown for removing air locks in the installation instructions section of this manual.

Important: A pump should not be allowed to run without priming for more than 2 minutes. Under NO circumstances should a pump be allowed to run without priming beyond the end of the 4-5 minute priming mode. Doing so may cause damage to the pump and cause the system to energize the heater and go into an overheat condition.

EXITING PRIMING MODE

You can manually exit Priming Mode by pressing a "Temp" button (Up or Down). Note that if you do not manually exit the priming mode as described above, the priming mode will be automatically terminated after 4-5 minutes. Be sure that the pump(s) have been primed by this time.

Once the system has exited Priming Mode, the top-side panel will momentarily display the set temperature but the display will not show the temperature yet, as shown below. This is because the system requires approximately 1 minute of water flowing through the heater to determine the water temperature and display it.



SPA CONTROLS

SPA BEHAVIOR

PUMPS

Press "Jets" or "Aux" button once to turn the pump on or off, and to shift between low and high speeds if equipped. If left running, the pump will turn off after a time-out period.

If the spa is in Ready Mode, Pump 1 low may also activate for at least 1 minute every 30 minutes to detect the spa temperature (polling) and then to heat to the set temperature if needed. When the low-speed turns on automatically, it cannot be deactivated from the panel, however the high speed may be started.

Circulation Pump

The 24 hour circ pump operates continuously with the exception of turning off for 30 minutes at a time when the water temperature reaches 3°F (1.5°C) above the set temperature (most likely to happen in warm climates).

FILTRATION AND OZONE

On non-circ systems, Pump 1 low and the ozone generator will run during filtration. On 24 hour circ systems, the ozone will run with the 24 hour circ pump.

The system is factory-programmed with two filter cycles that will run 10 minutes after power-up. The filter duration is programmable.

At the start of each filter cycle, Pump 2 (if there is one) will run briefly to purge its plumbing to maintain good water quality.

FREEZE PROTECTION

If the temperature sensors within the heater detect a low enough temperature, then the pump(s) automatically activate to provide freeze protection. The pump(s) will run either continuously or periodically depending on conditions. If the temperature sensors detect a drop to below 44°F/6.7°C within the heater, the pump will automatically activate to provide freeze protection. The equipment stays on until 4 minutes after the sensors detect that the spa temperature has risen to 45°F/7.2°C or higher. During freeze protection the heater will not be activated.

SPA CONTROLS

TEMPERATURE & TEMP RANGE

ADJUSTING THE SET TEMPERATURE

When using a panel with Up and Down buttons (Temperature buttons), pressing Up or Down will cause the temperature to flash. Pressing a temperature button again will adjust the set temperature in the direction indicated on the button. When the LCD stops flashing, the spa will heat to the new set temperature when required.

If the panel has a single temperature button, pressing the button will cause the temperature to flash. Pressing the button again will cause the temperature to change in one direction (e.g. UP). After allowing the display to stop flashing, pressing the Temperature Button will cause the temperature to flash and the next press will change the temperature in the opposite direction (e.g. DOWN).

The temperature can be set between 80°F and 104°F.

PRESS-AND-HOLD

If a Temperature button is pressed and held when the temperature is flashing, the temperature will continue to change until the button is released. If only one temperature button is available and the limit of the Temperature Range is reached when the button is being held, the progression will reverse direction.

SPA CONTROLS

MODE - READY & REST

In order for the spa to heat, a pump needs to circulate water through the heater. The pump that performs this function is known as the “heater pump.”

The heater pump can be either a 2-Speed Pump 1 or a 24 hour circulation pump.

If the heater pump is a 2-Speed Pump 1, READY Mode will circulate water every 1/2 hour, using Pump 1 Low, in order to maintain a constant water temperature, heat as needed, and refresh the temperature display. This is known as “polling.”

REST Mode will only allow heating during programmed filter cycles. Since polling does not occur, the temperature display may not show a current temperature until the heater pump has been running for a minute or two.

24 Hour Circulation Mode The 24 hour circ pump operates continuously with the exception of turning off for 30 minutes at a time when the water temperature reaches 3°F (1.5°C) above the set temperature (most likely to happen in warm climates).

If the spa is configured for 24HR circulation, the heater pump runs continuously. Since the heater pump is always running, the spa will maintain set temperature and heat as needed in Ready Mode, without polling.

In Rest Mode, the spa will only heat to set temperature during programmed filter times, even though the water is being filtered constantly when in Circulation Mode.

Key

- Indicates Flashing or Changing Segment
- Indicates Alternating or Progressive Message - every 1/2 second
- A temperature button, used for “Action”

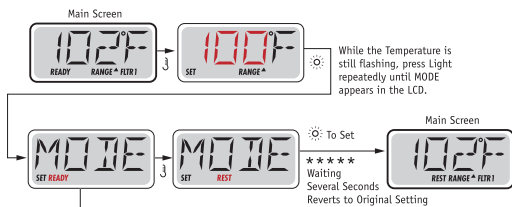

***** Waiting time (depends on menu item) that reverts to original setting and ignores any change to that menu item.

To next item in Main Menu If not toggled

Toggle between READY and REST Pressing Light when the display is toggled will go to Main Screen.

READY Mode will allow the spa to Poll and determine a need for heat. The panel will maintain a “current” temperature display.

REST Mode will not Poll and will only heat during filter cycles. The panel will not display a current temperature at all times.



The Main Screen will display RUN PUMP FOR TEMP if the filtration pump has not run for over 1 hour. The Main Screen will display normally during Filter Cycles or when the spa is in use.

If the filtration pump has been off for an hour or more, when any function button, EXCEPT Light, is pressed on the panel, the pump used in conjunction with the heater will run so that temperature can be sensed and displayed.

READY-IN-REST MODE

READY/REST appears in the display if the spa is in Rest Mode and Jet 1 is pressed. It is assumed that the spa is being used and will heat to set temperature. While Pump 1 High can be turned on and off, Pump 1 Low will run until set temperature is reached, or 1 hour has passed. After 1 hour, the System will revert to Rest Mode. This mode can also be reset by entering the Mode Menu and changing the Mode.



SPA CONTROLS

FLIP (INVERT DISPLAY)

Key

- Indicates Flashing or Changing Segment
- Indicates Alternating or Progressive Message - every 1/2 second
- ☀️ A temperature button, used for "Action"

Waiting time that keeps the last change to a menu item.

***** Waiting time (depends on menu item) that reverts to original setting and ignores any change to that menu item.

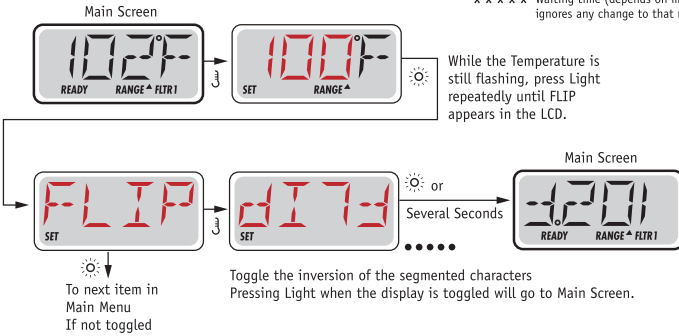

NOTE:

Some panels may have a dedicated FLIP button, which allows the user to flip the display with a single button-press.

ADJUSTING FILTRATION

MAIN FILTRATION

Filter cycles are set using a duration. Each setting can be adjusted in 1-hour increments. Filter Cycle 1 and Filter Cycle 2 (if enabled) are set to the same duration.

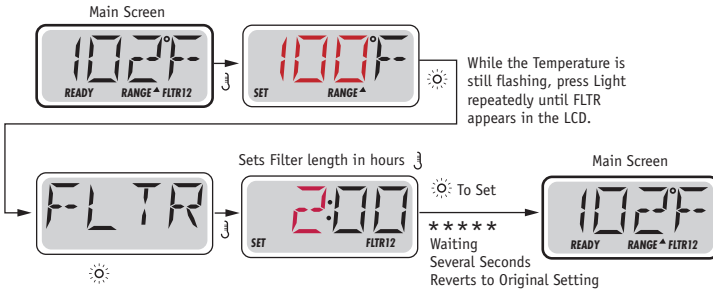

If Filter Cycle 2 is enabled, Filter 12 will appear in the LCD. If Filter is disabled, Filter 1 will appear.

PURGE CYCLES

In order to maintain sanitary conditions, secondary Pumps will purge water from their respective plumbing by running briefly at the beginning of each filter cycle.

SPA CONTROLS

GENERAL MESSAGES



PRIMING MODE

Each time the spa is powered up, it will enter Priming Mode. The purpose of Priming Mode is to allow the user to run each pump and manually verify that the pumps are primed (air is purged) and water is flowing. This typically requires observing the output of each pump separately, and is generally not possible in normal operation. Priming Mode lasts 4 minutes, but you can exit it earlier by pressing any Temp button. The heater is not allowed to run during Priming Mode.

NOTE: If your spa has a 24 hour Circ Pump, it will turn on with Jets 1 in Priming Mode. The 24 hour Circ Pump will run by itself when Priming Mode is exited.



WATER TEMPERATURE IS UNKNOWN

After the pump has been running for 1 minute, the temperature will be displayed.



TOO COLD - FREEZE PROTECTION

A potential freeze condition has been detected, and all pumps are activated. All pumps are ON for at least 4 minutes after the potential freeze condition has ended.

In some cases, pumps may turn on and off and the heater may operate during Freeze Protection.

This is an operational message, not an error indication.



WATER IS TOO HOT (OHS)

One of the water temp sensors has detected spa water temp 110°F (43.3°C) and spa functions are disabled. System will auto reset when the spa water temp is below 108°F (42.2°C). Check for extended pump operation or high ambient temp.

SPA CONTROLS

HEATER RELATED MESSAGES



HEATER FLOW IS REDUCED (HFL)

There may not be enough water flow through the heater to carry the heat away from the heating element. Heater start up will begin again after about 1 min. See "Flow Related Checks" below.



HEATER FLOW IS REDUCED (LF)*

There is not enough water flow through the heater to carry the heat away from the heating element and the heater has been disabled. See "Flow Related Checks" below. After the problem has been resolved, you must press any button to reset and begin heater start up.



HEATER MAY BE DRY (DR)*

Possible dry heater, or not enough water in the heater to start it. The spa is shut down for 15 min. Press any button to reset the heater start-up. See "Flow Related Checks" below.



HEATER IS DRY*

There is not enough water in the heater to start it. The spa is shut down. After the problem has been resolved, you must press any button to reset and restart heater start up. See "Flow Related Checks" below.



HEATER IS TOO HOT (OHH)*

One of the water temp sensors has detected 118°F (47.8°C) in the heater and the spa is shut down. You must press any button to reset when water is below 108°F (42.2°C). See "Flow Related Checks" below.



A RESET MESSAGE MAY APPEAR WITH OTHER MESSAGES.

Some errors may require power to be removed and restored.

FLOW-RELATED CHECKS

Check filters for possible blockage. Try cleaning or replacing filters (especially if spa is equipped with 24 hour circulation pump). Check for low water level, suction flow restrictions, closed valves, trapped air, too many closed jets and pump prime.

On some systems even when spa is shut down, some equipment may occasionally turn on to continue monitoring temperature or if freeze protection is needed.

* This message can be reset from the topside panel with any button press.

SPA CONTROLS

SENSOR RELATED MESSAGES



SENSOR BALANCE IS POOR

The temperature sensors MAY be out of sync by 2°F or 3°F. Call for Service.



SENSOR BALANCE IS POOR*

The temperature sensors are out of sync. The Sensor Balance is poor fault has been established for at least 1 hour. Call for Service.



SENSOR FAILURE – SENSOR A, SENSOR B

A temperature sensor or sensor circuit has failed. Call for Service.

MISCELLANEOUS MESSAGES



NO COMMUNICATIONS

The control panel is not receiving communication from the System. Call for Service.



°F OR °C IS REPLACED BY °T

The Control System is in Test Mode. Call for Service.

* This message can be reset from the topside panel with any button press.

SPA CONTROLS

SYSTEM RELATED MESSAGES



MEMORY FAILURE - CHECKSUM ERROR*

At Power-Up, the system has failed the Program Checksum Test. This indicates a problem with the firmware (operation program) and requires a service call.



MEMORY WARNING - PERSISTENT MEMORY RESET*

Appears after any system setup change. Contact your dealer or service organization if this message appears on more than one power-up, or if it appears after the system has been running normally for a period of time.



MEMORY FAILURE - CLOCK ERROR*

Contact your dealer or service organization.



CONFIGURATION ERROR – SPA WILL NOT START UP

Contact your dealer or service organization.



A PUMP APPEARS TO BE STUCK ON

Water may be overheated. POWER DOWN THE SPA. DO NOT ENTER THE WATER. Contact your dealer or service organization.



A PUMP APPEARS TO HAVE BEEN STUCK ON WHEN SPA WAS LAST POWERED

POWER DOWN THE SPA. DO NOT ENTER THE WATER. Contact your dealer or service organization.

* This message can be reset from the topside panel with any button press.

WI-FI MODULE (IF EQUIPPED)

Remotely control the operations of your spa via an optional integrated Wi-Fi module that works with the Balboa Water Group Wi-Fi Spa Control App. This app is available for Apple® or Android® devices. Please refer to the Balboa Water Group website and mobile device app for operation information.

<http://www.balboawater.com/bwa>

Note: WiFi Module is not available for all spa models. If this options was not added from the factory, see your Master Spas dealer for further details and compatibility.

DELUXE FUSION AIR STEREO OPTION (IF EQUIPPED)

The Deluxe Fusion Air option offers Bluetooth and FM audio modes. This system includes a water resistant, wireless remote for switching modes and controlling the audio.

Warning: Never remain in your spa longer than 15 minutes per session when the water temperature is above 98°F. If you wish to spend more time in your spa, whether enjoying music, or just lounging, be sure to keep the spa water at or below body temperature (98.6°F).

1.1 POWER ON

The Standard Fusion Air Stereo is always ready any time the spa is on and running.

1.2 REMOTE CONTROL

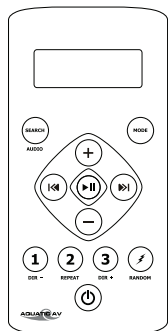

i In order to prolong remote battery life the LCD will shut off in 20 seconds if no other button is pressed. To turn remote back on press any key once and then press the command desired.

i Turn off DSP to access control of Bass and Treble.

i When in Bluetooth mode Repeat and Random playback functions must be enabled via your media device and not from the remote control.

Buttons		Music Mode: Bluetooth	FM Radio Mode
Power		Press Once: Turns remote control on. Press Twice: Toggle from Operation mode to Standby mode or vice-versa.	
Mode		Press once: Change the source. Press and hold: No function	Press once: Change the source. Press and hold: No function
Search/Audio		Press once: Search Press and hold: Audio Menu (BAS-TRE-BAL-FAD-EUR-DX-MONOSTEREO)	Press once: Audio Menu (BAS-TRE-BAL-FAD-EUR-DX-MONOSTEREO) Press and hold: Audio Menu (BAS-TRE-BAL-FAD-EUR-DXMONO-STEREO)
Volume Up		Press once: Volume up Press and hold: Fast volume up	Press once: Volume up Press and hold: Fast volume up
Volume Down		Press once: Volume down Press and hold: Fast volume down	Press once: Volume down Press and hold: Fast volume down
Play/Pause		Press once: Play/Pause Press and hold: No function	Press once: Toggle mute Press and hold: No function
Fast Rewind		Press once: Previous track Press and hold: Fast rewind	Press once: Scan down Press and hold: Toggle manual seeking
Fast Forward		Press once: Next track Press and hold: Fast forward	Press once: Scan up Press and hold: Toggle manual seeking
1 / DIR-		Press once: Back to previous folder Press and hold: No function	Press once: Listen to FM preset station 1 Press and hold: Set preset FM station 1
2 / REPEAT		Press once: Repeat playback function Press and hold: Repeat function	Press once: Listen to FM preset station 2 Press and hold: Set preset FM station 2
3 / DIR+		Press once: Forward to next folder Press and hold: No function	Press once: Listen to FM preset station 3 Press and hold: Set preset FM station 3
12V Trigger / Random		Press once: Random playback function	No Function



DELUXE FUSION AIR STEREO OPTION

1.3 HANDHELD REMOTE CONTROL BATTERY INSTALL

Unscrew the waterproof cap on the back of the remote control. Place the CR-2450 battery in the RF remote control and replace the water/dust proof cap. When the battery is installed, the remote control LCD should be solid and bright without any flickering.

1.4 HANDHELD REMOTE CONTROL SYNCHRONIZING

The remote should already be paired from the factory, but if you need to re synchronize the remote follow the steps below.

1. Press the  POWER button on the remote control to turn on the remote.
2. The LCD will become illuminated and read 'NO LINK'.
3. Press and hold the  MODE button for 5 – 10 seconds.
4. Once the remote has been paired, the LCD will display one of the audio modes (BT AUDIO or AUX).

For any additional remote controls, you will also need to activate/synchronize those remote controls by following the steps above.

i *If the pairing process is not effective, check the battery voltage of the remote. If above 3V DC refer to section 1.5 above top make sure the battery is installed correctly. If battery voltage is below 3V DC replace the battery.*

i *If the LCD displays "NO LINK" in any mode, this means the remote is out of reception range or not paired correctly. Move the remote closer to the unit and try again.*



i *If you lose your remote control and buy a new remote control, please follow the above to pair remote control.*

2.1 PAIR WITH BLUETOOTH DEVICE

1. Switch on your Bluetooth device.
2. Select 'AQUATIC AV' from the list of available devices to pair (no password is needed).

i *Only one Bluetooth device can be paired with the BlueCube Media Player at any time.*

2.2 LISTENING VIA BLUETOOTH DEVICE

1. Bluetooth mode will be activated once a Bluetooth device is paired.
2. Play the song from device and the sound will play through the BlueCube Media Player.
3. Press  (PLAY/PAUSE) to play/pause the song.
4. Press  /  (FAST REWIND/FORWARD) buttons to play previous/next song file.
5. Track and volume can be controlled directly from your Bluetooth device or remote control.

DELUXE FUSION AIR STEREO OPTION

3.1 LISTENING VIA FM

1. Press  (MODE) on remote control to switch to FM radio mode.

i If this is the first time you listen to FM radio, the default frequency will be 87.5MHz, as shown on the remote LCD.

i FM radio is only available when you are in the FM Radio mode.



3.2 SCAN OR SEEK FM RADIO CHANNELS

1. Press  (FAST REWIND) or  (FAST FORWARD) to seek another station.



2. Press and hold either  (FAST REWIND) or  (FAST FORWARD) for manual tuning back or forward.

i After using Seek mode the unit will automatically switch back into Scan mode after 20 seconds.

3.3 SAVING RADIO CHANNEL TO MEMORY

To save the current frequency into memory, press and hold   or  for more than 2 seconds. The station will be stored into relevant button.

3.4 LISTENING TO SAVED RADIO MEMORY

Press the  ,  or  preset button once to listen to the station stored in that button.

3.5 SWITCH BETWEEN US AND EUROPEAN FM MODES

1. Make sure dock and remote are turned on and in 'RADIO' mode.

2. Press the AUDIO button 6 time in a row.

3. The remote will display 'AREA USA' or 'AREA EUR' depending on which tuning mode is currently selected.

4. Use the  and  buttons to switch between US or European modes.

5. Press  (PLAY/PAUSE) to select the desired tuning mode.

6. Once you switch modes it will default to the FM station stored in 'PRESET'.

i US mode will increase and decrease the FM frequency in steps of 0.1 MHz, e.g. 88.5, 88.6, 88.7 MHz. EUR mode will increase and decrease the FM frequency in steps of 0.05 MHz, e.g. 88.25, 88.30, 88.35 MHz.

i When in Seek mode and European FM tuning mode, all frequency steps will be visible.

4.1 ADJUST VOLUME LEVEL

1. Press  (VOLUME UP) once to increase the volume.

2. Press  (VOLUME DOWN) once to reduce the volume.

3. Press and hold either  or  and the BlueCube Media Player will increase or decrease audio volume continuously.



Legacy Whirlpool™

are manufactured by Master Spas,
one of the world's leading spa manufacturers.

Master Spas Inc.
6927 Lincoln Parkway
Fort Wayne, IN 46804
800.860.7727

CustomerService@MasterSpas.com
www.MasterSpas.com

The manufacturer reserves the right to change specifications or features without notice. As a manufacturer of spas and related products we stand behind every product we produce pursuant to those representations which are stated in our written limited warranty. Your dealer is an independent business person or company and not an employee or agent of the manufacturer. We cannot and do not accept any responsibility or liability for any other representations, statements or contracts made by any dealer beyond the provisions of our written limited warranty.

POP16LWOM
Rev. 201606